

# Technical Reference



## **AWG7000 Series Arbitrary Waveform Generators Specifications and Performance Verification**

**077-0172-00**

### **Warning**

The servicing instructions are for use by qualified personnel only. To avoid personal injury, do not perform any servicing unless you are qualified to do so. Refer to all safety summaries prior to performing service.

**[www.tektronix.com](http://www.tektronix.com)**

Copyright © Tektronix. All rights reserved. Licensed software products are owned by Tektronix or its subsidiaries or suppliers, and are protected by national copyright laws and international treaty provisions.

Tektronix products are covered by U.S. and foreign patents, issued and pending. Information in this publication supercedes that in all previously published material. Specifications and price change privileges reserved.

TEKTRONIX and TEK are registered trademarks of Tektronix, Inc.

## **Contacting Tektronix**

Tektronix, Inc.  
14200 SW Karl Braun Drive  
P.O. Box 500  
Beaverton, OR 97077  
USA

For product information, sales, service, and technical support:

- In North America, call 1-800-833-9200.
- Worldwide, visit [www.tektronix.com](http://www.tektronix.com) to find contacts in your area.

## Warranty 2

Tektronix warrants that this product will be free from defects in materials and workmanship for a period of one (1) year from the date of shipment. If any such product proves defective during this warranty period, Tektronix, at its option, either will repair the defective product without charge for parts and labor, or will provide a replacement in exchange for the defective product. Batteries are excluded from this warranty. Parts, modules and replacement products used by Tektronix for warranty work may be new or reconditioned to like new performance. All replaced parts, modules and products become the property of Tektronix.

In order to obtain service under this warranty, Customer must notify Tektronix of the defect before the expiration of the warranty period and make suitable arrangements for the performance of service. Customer shall be responsible for packaging and shipping the defective product to the service center designated by Tektronix, shipping charges prepaid, and with a copy of customer proof of purchase. Tektronix shall pay for the return of the product to Customer if the shipment is to a location within the country in which the Tektronix service center is located. Customer shall be responsible for paying all shipping charges, duties, taxes, and any other charges for products returned to any other locations

This warranty shall not apply to any defect, failure or damage caused by improper use or improper or inadequate maintenance and care. Tektronix shall not be obligated to furnish service under this warranty a) to repair damage resulting from attempts by personnel other than Tektronix representatives to install, repair or service the product; b) to repair damage resulting from improper use or connection to incompatible equipment; c) to repair any damage or malfunction caused by the use of non-Tektronix supplies; or d) to service a product that has been modified or integrated with other products when the effect of such modification or integration increases the time or difficulty of servicing the product.

**THIS WARRANTY IS GIVEN BY TEKTRONIX WITH RESPECT TO THE PRODUCT IN LIEU OF ANY OTHER WARRANTIES, EXPRESS OR IMPLIED. TEKTRONIX AND ITS VENDORS DISCLAIM ANY IMPLIED WARRANTIES OF MERCHANTABILITY OR FITNESS FOR A PARTICULAR PURPOSE. TEKTRONIX' RESPONSIBILITY TO REPAIR OR REPLACE DEFECTIVE PRODUCTS IS THE SOLE AND EXCLUSIVE REMEDY PROVIDED TO THE CUSTOMER FOR BREACH OF THIS WARRANTY. TEKTRONIX AND ITS VENDORS WILL NOT BE LIABLE FOR ANY INDIRECT, SPECIAL, INCIDENTAL, OR CONSEQUENTIAL DAMAGES IRRESPECTIVE OF WHETHER TEKTRONIX OR THE VENDOR HAS ADVANCE NOTICE OF THE POSSIBILITY OF SUCH DAMAGES**



# Table of Contents

<b>General Safety Summary</b> .....	<b>v</b>
<b>Environmental Considerations</b> .....	<b>vii</b>
<b>Preface</b> .....	<b>ix</b>
Related Documents .....	ix

## Specifications

Performance Conditions .....	1-1
Electrical Specifications .....	1-2
Mechanical (Physical) Characteristics .....	1-12
Environmental Characteristics .....	1-13
Certifications and Compliances .....	1-14

## Performance Verification

<b>Brief Procedures</b> .....	<b>2-3</b>
Diagnostics .....	2-3
Calibration .....	2-4
Functional Test .....	2-5
<b>Performance Tests</b> .....	<b>2-9</b>
Prerequisites .....	2-9
Equipment Required .....	2-9
Test Record .....	2-11
10 MHz Reference Frequency Accuracy .....	2-20
Analog Offset Accuracy .....	2-21
Analog Amplitude Accuracy .....	2-24
Analog Harmonic Distortion .....	2-26
Analog Non-Harmonic Spurious Signal .....	2-29
Analog Phase Noise .....	2-31
Marker High and Low Level Accuracy .....	2-34
Marker Output Delay Accuracy .....	2-37
DC Output Voltage Accuracy .....	2-40

## List of Figures

<b>Figure 2-1: Diagnostics dialog box</b> .....	<b>2-4</b>
<b>Figure 2-2: Calibration dialog box</b> .....	<b>2-5</b>
<b>Figure 2-3: Equipment connections for checking the analog and marker outputs</b> .....	<b>2-6</b>
<b>Figure 2-4: Output waveform from the Analog, Mkr1, and Mkr 2 connectors</b> .....	<b>2-8</b>
<b>Figure 2-5: Equipment connection for verifying the 10 MHz reference frequency accuracy</b> .....	<b>2-20</b>
<b>Figure 2-6: Equipment connection for measuring the terminator resistance</b> .....	<b>2-21</b>
<b>Figure 2-7: Equipment connection for verifying the analog offset accuracy</b> .....	<b>2-22</b>
<b>Figure 2-8: Equipment connections for verifying the analog harmonic distortion</b> .....	<b>2-27</b>
<b>Figure 2-9: Equipment connections for verifying the non-harmonic spurious signal</b> .....	<b>2-29</b>
<b>Figure 2-10: Equipment connections for verifying the analog phase noise</b> .....	<b>2-32</b>
<b>Figure 2-11: Example of the analog phase noise measurement</b> .....	<b>2-33</b>
<b>Figure 2-12: Equipment connection for verifying the marker high and low level accuracy</b> .....	<b>2-34</b>
<b>Figure 2-13: Equipment connections for verifying the marker output delay accuracy</b> .....	<b>2-38</b>
<b>Figure 2-14: Equipment connection for verifying the DC output voltage accuracy</b> .....	<b>2-40</b>

# List of Tables

<b>Table 1-1: Run mode</b> .....	<b>1-2</b>
<b>Table 1-2: Arbitrary waveform</b> .....	<b>1-2</b>
<b>Table 1-3: Clock generator</b> .....	<b>1-3</b>
<b>Table 1-4: Trigger generator</b> .....	<b>1-3</b>
<b>Table 1-5: Inter-channel skew control (2 channels model only)</b> ....	<b>1-3</b>
<b>Table 1-6: Analog output (standard)</b> .....	<b>1-4</b>
<b>Table 1-7: Analog output (Option 02 and Option 06)</b> .....	<b>1-6</b>
<b>Table 1-8: Interleave analog output (AWG7102 Option 06)</b> .....	<b>1-7</b>
<b>Table 1-9: Marker output</b> .....	<b>1-8</b>
<b>Table 1-10: Trigger and gate input</b> .....	<b>1-8</b>
<b>Table 1-11: Event input</b> .....	<b>1-9</b>
<b>Table 1-12: Reference clock input</b> .....	<b>1-10</b>
<b>Table 1-13: Oscillator (external clock) input</b> .....	<b>1-10</b>
<b>Table 1-14: DC output</b> .....	<b>1-10</b>
<b>Table 1-15: 10 MHz clock output</b> .....	<b>1-11</b>
<b>Table 1-16: TekLink port</b> .....	<b>1-11</b>
<b>Table 1-17: CPU module and peripheral devices</b> .....	<b>1-11</b>
<b>Table 1-18: Display</b> .....	<b>1-12</b>
<b>Table 1-19: Power supply</b> .....	<b>1-12</b>
<b>Table 1-20: Mechanical characteristics</b> .....	<b>1-12</b>
<b>Table 1-21: Environmental characteristics</b> .....	<b>1-13</b>
<b>Table 1-22: Certifications and compliances</b> .....	<b>1-14</b>
<b>Table 2-1: Equipment required</b> .....	<b>2-9</b>
<b>Table 2-2: Test waveforms</b> .....	<b>2-10</b>
<b>Table 2-3: Analog offset accuracy</b> .....	<b>2-23</b>
<b>Table 2-4: Analog amplitude accuracy</b> .....	<b>2-25</b>
<b>Table 2-5: Analog harmonic distortion</b> .....	<b>2-28</b>
<b>Table 2-6: Analog non-harmonic spurious signal</b> .....	<b>2-30</b>
<b>Table 2-7: Analog phase noise</b> .....	<b>2-33</b>
<b>Table 2-8: Marker High and Low level accuracy</b> .....	<b>2-35</b>
<b>Table 2-9: DC output voltage accuracy</b> .....	<b>2-41</b>





# General Safety Summary

Review the following safety precautions to avoid injury and prevent damage to this product or any products connected to it. To avoid potential hazards, use this product only as specified.

*Only qualified personnel should perform service procedures.*

## **To Avoid Fire or Personal Injury**

**Use Proper Power Cord.** Use only the power cord specified for this product and certified for the country of use.

**Ground the Product.** This product is grounded through the grounding conductor of the power cord. To avoid electric shock, the grounding conductor must be connected to earth ground. Before making connections to the input or output terminals of the product, ensure that the product is properly grounded.

**Observe All Terminal Ratings.** To avoid fire or shock hazard, observe all ratings and markings on the product. Consult the product manual for further ratings information before making connections to the product.

**Do Not Operate Without Covers.** Do not operate this product with covers or panels removed.

**Avoid Exposed Circuitry.** Do not touch exposed connections and components when power is present.

**Do Not Operate With Suspected Failures.** If you suspect there is damage to this product, have it inspected by qualified service personnel.

**Do Not Operate in Wet/Damp Conditions.**

**Do Not Operate in an Explosive Atmosphere.**

**Keep Product Surfaces Clean and Dry.**

**Provide Proper Ventilation.** Refer to the manual's installation instructions for details on installing the product so it has proper ventilation.

**No Power Switch.** Power supply cord is considered the disconnecting device, disconnect the main power by means of the power cord.

**Symbols and Terms**

**Terms in this Manual.** These terms may appear in this manual:



---

**WARNING.** *Warning statements identify conditions or practices that could result in injury or loss of life.*

---



---

**CAUTION.** *Caution statements identify conditions or practices that could result in damage to this product or other property.*

---

**Terms on the Product.** These terms may appear on the product:

DANGER indicates an injury hazard immediately accessible as you read the marking.

WARNING indicates an injury hazard not immediately accessible as you read the marking.

CAUTION indicates a hazard to property including the product.

**Symbols on the Product.** The following symbols may appear on the product:



# Environmental Considerations

This section provides information about the environmental impact of the product.

## Product End-of-Life Handling

Observe the following guidelines when recycling an instrument or component:

**Equipment Recycling.** Production of this equipment required the extraction and use of natural resources. The equipment may contain substances that could be harmful to the environment or human health if improperly handled at the product's end of life. In order to avoid release of such substances into the environment and to reduce the use of natural resources, we encourage you to recycle this product in an appropriate system that will ensure that most of the materials are reused or recycled appropriately.



The symbol shown to the left indicates that this product complies with the European Union's requirements according to Directive 2002/96/EC on waste electrical and electronic equipment (WEEE). For information about recycling options, check the Support/Service section of the Tektronix Web site ([www.tektronix.com](http://www.tektronix.com)).

**Mercury Notification.** This product uses an LCD backlight lamp that contains mercury. Disposal may be regulated due to environmental considerations. Please contact your local authorities or, within the United States, the Electronics Industries Alliance ([www.eiae.org](http://www.eiae.org)) for disposal or recycling information.

## Restriction of Hazardous Substances

This product has been classified as Monitoring and Control equipment, and is outside the scope of the 2002/95/EC RoHS Directive. This product is known to contain lead, cadmium, mercury, and hexavalent chromium.



# Preface

This manual contains specifications and performance verification procedures for the AWG7000 Series Arbitrary Waveform Generators.

## Related Documents

The following user documents are also available for this product:

- *AWG7000 Series Arbitrary Waveform Generators Quick Start User Manual.*  
This document describes the functions and use of the instrument.
- *AWG7000 Series Arbitrary Waveform Generators Service Manual.*  
This is an optional accessory that provides module-level service information.





# Specifications





# Specifications

This section contains the specifications for the AWG7101, AWG7102, AWG7051, and AWG7052 Arbitrary Waveform Generators.

All specifications are guaranteed unless noted as “typical”. Typical specifications are provided for your convenience but are not guaranteed. Specifications that are marked with the ✓ symbol are checked in the Performance Verification section of this manual.

## Performance Conditions

To meet specifications, following conditions must be met:

- The instrument must have been calibrated/adjusted at an ambient temperature between +20 °C and +30 °C.
- The instrument must have been operating continuously for 20 minutes within the operating temperature range specified.
- The instrument must be in an environment where the temperature, altitude, humidity, and vibration conditions are within the operating limits described in these specifications.

## Electrical Specifications

**Table 1-1: Run mode**

Characteristics	Description
Continuous mode	An arbitrary waveform is output continuously.
Triggered mode	An arbitrary waveform is output only once when a trigger signal is applied. After the waveform is output, the instrument waits for the next trigger signal.
Gated mode	An arbitrary waveform is output only when a gate signal is asserted. The waveform output is repeated while the gate signal stays asserted. When the gate signal is deasserted, the waveform output stops immediately.
Sequence mode	A sequence of arbitrary waveforms are output.

**Table 1-2: Arbitrary waveform**

Characteristics	Description
Waveform length	
Without Option 01	1 to 32,400,000 points (interleave is off) 1 to 64,800,000 points (interleave is on)
With Option 01	1 to 64,800,000 points (interleave is off) 1 to 129,600,000 points (interleave is on)
Waveform granularity	1 point
DAC resolution	10 bits or 8 bits selectable (when the 10 bits DAC mode is selected, marker output is disabled.)
Number of waveforms	1 to 32,000 waveforms
Sequence length	1 to 4,000 steps
Sequence controls	Repeat count, Wait-for-Trigger, Go-to-N, and Jump are available.
Repeat count	1 to 65,536 or infinite (all channels operate the same sequence)
Jump timing	Synchronous or Asynchronous selectable

**Table 1-3: Clock generator**

Characteristics	Description
Sampling rate control	
Range	
AWG7101 and AWG7102	10.0000 MS/s to 10.0000 GS/s (interleave is off)
AWG7102 Option 06 <sup>1</sup>	10.0000 GS/s to 20.0000 GS/s (interleave is on)
AWG7051 and AWG7052	10.0000 MS/s to 5.0000 GS/s
Resolution	8 digits
✓ Internal clock frequency accuracy	Within $\pm$ (1 ppm +aging)
Internal clock frequency accuracy, typical	Aging: within $\pm$ 1 ppm/year
Reference oscillator accuracy	Within $\pm$ (1 ppm +aging)
Reference oscillator accuracy, typical	Aging: within $\pm$ 1 ppm/year

<sup>1</sup> Interleaving is applied to analog output. When interleaving is on, marker data with even numbers will be output.

**Table 1-4: Trigger generator**

Characteristics	Description
Trigger rate	
Range	1.0 $\mu$ s to 10.0 s
Resolution	3 digits and 0.1 $\mu$ s minimum
Accuracy	Same as the reference oscillator

**Table 1-5: Inter-channel skew control (2 channels model only)**

Characteristics	Description
Skew control	
Range	-100 ps to +100 ps
Resolution	1 ps
Skew accuracy	$\pm$ (10% of setting +10 ps)

**Table 1-6: Analog output (standard)**

Characteristics	Description
Connector type	SMA
Type of output	(+) and (-) complementary output
Output impedance	50 $\Omega$
Amplitude controls	
Range	
Normal mode	50 mV to 2.0 V peak-peak
Direct D/A mode	50 mV to 1.0 V peak-peak
Resolution	1 mV
Offset controls	
Range	
Normal mode	-0.5 V to +0.5 V
Direct D/A mode	N/A
Resolution	1 mV
✓ Amplitude accuracy	Within $\pm$ (3% of amplitude + 2 mV) at offset=0V
✓ Offset accuracy	Within $\pm$ (2% of amplitude + 10 mV) at minimum amplitude
Bandwidth, typical	
Normal mode	750 MHz, at -3 dB
Direct D/A mode	3.5 GHz, at -3 dB
Rise/fall time, typical	
Normal mode	350 ps (20% to 80%), when amplitude= 2.0 Vp-p, offset=0 V
Direct D/A mode	75 ps (20% to 80%), when amplitude=1.0 Vp-p
Overshoot, typical	< 10%, when amplitude=1.0 Vp-p
Low pass filter	
Normal mode	50 MHz, 200 MHz, Through (Bessel type)
Direct D/A mode	N/A
Delay from marker, typical	9.7 ns: low pass=50 MHz 3.9 ns: low pass=200 MHz 2.1 ns: low pass=through 0.5 ns: direct D/A mode (when amplitude=1.0 Vp-p, offset=0 V)
Skew between (+) and (-) outputs, typical	< 20 ps (direct D/A mode)
ON/OFF control	Output relay is available for each channel. A control is common to the complementary output.

**Table 1-6: Analog output (standard) (Cont.)**

Characteristics	Description
✓ Harmonic distortion	Amplitude=1.0 Vp-p, offset=0 V, DAC resolution =8 bit, measured with 32 points sine waveform
AWG710x Normal mode	< -35 dBc, when clock=10 GS/s, signal=312.5 MHz
AWG710x Direct D/A mode	< -42 dBc, when clock=10 GS/s, signal=312.5 MHz
AWG705x Normal mode	< -40 dBc, when clock=5 GS/s, signal=156 MHz
AWG705x Direct D/A mode	< -45 dBc, when clock=5 GS/s, signal=156 MHz
✓ Non harmonic spurious	Amplitude=1.0 Vp-p, offset=0 V, measured with 32 points sine waveform
AWG7101 and AWG7102	< -50 dBc, DC to 5 GHz, when clock=10 GS/s, signal=312.5 MHz
AWG7051 and AWG7052	< -50 dBc, DC to 2.5 GHz, when clock=5 GS/s, signal=156 MHz
SFDR, typical	Normal output mode, amplitude=1.0 Vp-p, offset=0 V, DAC resolution =10 bits
AWG7101 and AWG7102	45 dB, when clock=10 GS/s, signal=312.5 MHz
AWG7051 and AWG7052	51 dBc, when clock=5 GS/s, signal=156 MHz
✓ Phase noise	Normal output mode, amplitude=1.0 Vp-p, offset=0 V, DAC resolution =8 bits
AWG7101 and AWG7102	< -90 dBc/Hz at 10 kHz offset, when clock=10 GS/s, signal=312.5 MHz
AWG7051 and AWG7052	< -90 dBc/Hz at 10 kHz offset, when clock=5 GS/s, signal=156 MHz
Random jitter on clock pattern, typical	By 0101... clock pattern, amplitude=1.0 Vp-p, offset=0 V
Normal mode	1.6 ps
Direct D/A mode	0.9 ps
Total jitter on random pattern, typical	PN15 pattern, amplitude=1.0 Vp-p, offset=0 V, measured at bit error rate=1e-12
Normal mode	50 ps p-p at 500 MS/s
Direct D/A mode	30 ps p-p from 1 GS/s to 6 GS/s

**Table 1-7: Analog output (Option 02 and Option 06)**

Characteristics	Description
Connector type	SMA
Type of output	(+) and (-) complementary outputs
Output impedance	50 $\Omega$
Amplitude controls	
Range	0.5 V to 1.0 V peak-peak
Resolution	1 mV
✓ Amplitude accuracy	Within $\pm$ (2% of amplitude + 2 mV) at offset=0V
✓ DC offset accuracy	Within $\pm$ 10 mV
Bandwidth, typical	5.8 GHz at -3 dB
Rise/fall time, typical	45 ps (20% to 80%), when amplitude= 1.0 Vp-p
Overshoot, typical	< 3%, when amplitude=1.0 Vp-p
Delay from marker, typical	
Option 02	0.2 ns, when amplitude=1.0 Vp-p
Option 06	1.0 ns, when amplitude=1.0 Vp-p
Skew between (+) and (-) outputs, typical	< 20 ps
ON/OFF control	Output relay is available for each channel. A control is common to the complementary output.
✓ Harmonic distortion	Amplitude=1.0 Vp-p, measured with 32 points sine waveform
AWG7101 and AWG7102	< -42 dBc, when clock=10 GS/s, signal=312.5 MHz
AWG7051 and AWG7052	< -45 dBc, when clock=5 GS/s, signal=156 MHz
✓ Non harmonic spurious	Amplitude=1.0 Vp-p, measured with 32 points sine waveform
AWG7101 and AWG7102	< -50 dBc, DC to 5 GHz, when clock=10 GS/s, signal=312.5 MHz
AWG7051 and AWG7052	< -50 dBc, DC to 2.5 GHz, when clock=5 GS/s, signal=156 MHz
SFDR, typical	Amplitude=1.0 Vp-p, DAC resolution=10 bits
AWG7101 and AWG7102	44 dB, when clock=10 GS/s, signal=312.5 MHz
AWG7051 and AWG7052	48 dB, when clock=5 GS/s, signal=156 MHz
✓ Phase noise	Amplitude=1.0 Vp-p, measured with 32 points sine waveform
AWG7101 and AWG7102	< -90 dBc/Hz at 10 kHz offset, when clock=10 GS/s, signal=312.5 MHz
AWG7051 and AWG7052	< -90 dBc/Hz at 10 kHz offset, when clock=5 GS/s, signal=156 MHz
Random jitter on clock pattern, typical	0.9 ps rms, by 0101... clock pattern, amplitude=1.0 Vp-p
Total jitter on random pattern, typical	20 ps p-p from 2 GS/s to 10 GS/s, PN15 pattern, amplitude=1.0 Vp-p, measured at bit error rate =1 e-12.

**Table 1-8: Interleave analog output (AWG7102 Option 06)**

Characteristics	Description
Connector type	SMA
Type of output	(+) and (-) complementary output
Output impedance	50 $\Omega$
Zeroing control	Zeroing On and Off is selectable.
Amplitude controls	
Range	
When Zeroing is On	0.25 V to 0.5 V peak-peak
When Zeroing is Off	0.5 V to 1.0 V peak-peak
Resolution	1 mV
Amplitude accuracy, typical	Within $\pm$ (8% of amplitude + 2 mV) at offset=0V
✓ DC offset accuracy	Within $\pm$ 10 mV
Bandwidth, typical	5.8 GHz at -3 dB, when amplitude=0.5 Vp-p, zeroing=On
Rise/fall time, typical	45 ps (20% to 80%), when amplitude= 0.5 Vp-p, zeroing=On
Delay from marker, typical	1.0 ns when amplitude=0.5 Vp-p, zeroing=On
Skew between (+) and (-) outputs, typical	< 20 ps
ON/OFF control	Output relay is available for each channel. A control is common to the complementary output.
Harmonic distortion, typical	Measured with 32 points sine waveform
When Zeroing is On	< -40 dBc, when amplitude=0.5 Vp-p, clock=20 GS/s, signal=625 MHz
When Zeroing is Off	< -40 dBc, when amplitude=1.0 Vp-p, clock=20 GS/s, signal=625 MHz
Non harmonic spurious, typical	Measured with 32 points sine waveform
When Zeroing is On	< -45 dBc, DC to 5 GHz, when amplitude=0.5 Vp-p, clock=20 GS/s, signal=625 MHz
When Zeroing is Off	< -45 dBc, DC to 5 GHz, when amplitude=1.0 Vp-p, clock=20 GS/s, signal=625 MHz
SFDR, typical	clock=20 GS/s, signal=2.5 GHz
When Zeroing is On	30 dB, when amplitude=0.5 Vp-p
When Zeroing is Off	40 dB, when amplitude=1.0 Vp-p
✓ Phase noise	Measured with 32 points sine waveform
When Zeroing is On	< -85 dBc/Hz at 10 kHz offset, when amplitude=0.5 Vp-p, clock=20 GS/s, signal=625 MHz
When Zeroing is Off	< -85 dBc/Hz at 10 kHz offset, when amplitude=1.0 Vp-p, clock=20 GS/s, signal=625 MHz

**Table 1-9: Marker output**

Characteristics	Description
Connector type	SMA
Number of outputs	Marker 1 and Marker 2 are available for each channel.
Type of output	(+) and (-) complementary output
Level controls	
Voltage window	-1.4 V to +1.4 V into 50 $\Omega$
Amplitude	0.5 V <sub>p-p</sub> to 1.4 V <sub>p-p</sub> into 50 $\Omega$
Resolution	0.01 V
✓ Level accuracy	$\pm$ (10% of setting + 50 mV) into 50 $\Omega$
Output current	$\pm$ 28 mA max
Variable delay control	Available for Marker 1 and Marker 2
Range	0 to 300 ps
Resolution	1 ps
✓ Variable delay accuracy	$\pm$ (5% of setting + 50 ps)
Rise/fall time, typical	45 ps (20% to 80% of swing), when Hi= 1.0 V, Low=0V
Random jitter on clock pattern, typical	1 ps rms (by 0101... clock pattern), when Hi= 1.0 V, Low=0V
Total jitter on random pattern, typical	30 ps p-p (by PN15 pattern pattern, when Hi= 1.0 V, Low=0V, measured at bit error rate=1e-12)
Skew between (+) and (-) outputs, typical	< 13 ps
Skew between Marker 1 and Marker 2 outputs, typical	< 30 ps

**Table 1-10: Trigger and gate input**

Characteristics	Description
Connector type	BNC
Input impedance	1 k $\Omega$ or 50 $\Omega$ selectable
Polarity	Positive or negative selectable
Input voltage range	
When 1 k $\Omega$ selected	-10 V to 10 V
When 50 $\Omega$ selected	< 5 V rms



**Table 1-10: Trigger and gate input (Cont.)**

Characteristics	Description
Threshold control	
Level	-5.0 V to 5.0 V
Resolution	0.1 V
Accuracy, typical	± (5% of setting + 0.1 V)
Input voltage swing	0.5 Vp-p minimum
Minimum pulse width	
Trigger mode	20 ns
Gate mode	1024 * sampling period + 10 ns
Trigger delay to analog output, typical	128 * sampling period + 250 ns
Trigger hold off, typical	832 * sampling period - 100 ns
Gate delay to analog output, typical	640 * sampling period + 260 ns
Trigger jitter, typical	3 ns

**Table 1-11: Event input**

Characteristics	Description
Connector type	BNC
Input impedance	1 k $\Omega$ or 50 $\Omega$ selectable
Polarity	Positive or negative selectable
Input voltage range	
When 1 k $\Omega$ selected	-10 V to 10 V
When 50 $\Omega$ selected	< 5 Vrms
Threshold control	
Level	-5.0 V to 5.0 V
Resolution	0.1 V
Accuracy, typical	± (5% of setting + 0.1 V)
Input voltage swing	0.5 Vp-p minimum
Minimum pulse width	20 ns
Delay to analog output, typical	1024 * sampling period + 280 ns
Hold off time, typical	900 * sampling period + 10 ns

**Table 1-12: Reference clock input**

Characteristics	Description
Connector type	BNC
Input impedance	50 $\Omega$ (AC coupled)
Input voltage swing	0.2 Vp-p to 3 Vp-p
Fixed mode input frequency	10 MHz, 20 MHz, and 100 MHz within $\pm 0.1\%$
Variable mode input frequency range	5 MHz to 800 MHz Acceptable frequency drift while running is $\pm 0.1\%$
Variable mode multiplier rate	
AWG710x without interleave	1 to 2000
AWG7102 with interleave	2 to 4000
AWG705x	1 to 1000

**Table 1-13: Oscillator (external clock) input**

Characteristics	Description
Connector type	SMA
Input impedance	50 $\Omega$ (AC coupled)
Frequency range	5.0 GHz to 10.0 GHz
Input voltage swing	+ 5 dBm to +11 dBm
Divider	
AWG710x	1/1, 1/2, 1/4, 1/8, ... ,1/256
AWG705x	1/2, 1/4, 1/8, ... ,1/256

**Table 1-14: DC output**

Characteristics	Description
Connector type	2 x 4 pin header, 2.54 mm pitch (female)
Number of outputs	4
Output voltage control	
Range	-3.0 V to +5.0 V
Resolution	10 mV
Control	Independent for each output
↗ Output voltage accuracy	$\pm$ (3% of setting + 80 mV) into Hi-Z load
Output current	$\pm$ 100 mA maximum
Output impedance, typical	1 $\Omega$

**Table 1-15: 10 MHz clock output**

Characteristics	Description
Connector type	BNC
Output impedance	50 $\Omega$ (AC coupled)
Amplitude, typical	1.2 Vp-p into 50 $\Omega$ 2.4 Vp-p into 1 M $\Omega$

**Table 1-16: TekLink port**

Characteristics	Description
Connector type	40 pin
Function	Future capability.

**Table 1-17: CPU module and peripheral devices**

Characteristics	Description
CPU	Celeron D processor
Memory	512 MB DDR2-SDRAM
Hard disk drive	More than 80 GB
Optical disk drive	CD-RW/DVD drive
USB 2.0 port	6 (2 x front, 4 x rear)
LAN port	1000/100/10 BASE-T
Video output port	D-sub, 15 pin
GPIB port	IEEE 488.2 standard interface, 24 pin
Keyboard port	PS-2 compatible, mini-DIN, 6-pin
Mouse port	PS-2 compatible, mini-DIN, 6-pin
Serial port	RS-232C, D-sub, 9 pin
Parallel port	D-sub, 25 pin
Audio connectors	Line output, line input, mic input, stereo jack
Real time clock	Lifetime > 3 years (CR2032: Li 3 V 220 mAh)

**Table 1-18: Display**

Characteristics	Description
Size	210 mm X 158 mm
Resolution	1024 X 768 pixels
Touch screen	Built-in touch screen

**Table 1-19: Power supply**

Characteristics	Description
Source voltage and frequency	
Rating voltage	100 VAC to 240 VAC
Voltage range	90 VAC to 250 VAC
Frequency range	47 Hz to 63 Hz
Power consumption	450 W
Surge current	30 A peak (25 °C) for ≤ 5 line cycles, after product has been turned off for at least 30 s.

## Mechanical (Physical) Characteristics

**Table 1-20: Mechanical characteristics**

Characteristics	Description
Net weight	
Without package	Approximately 19 kg (41.9 lb)
With package	Approximately 28 kg (61.7 lb)
Dimensions	
Height	245 mm (9.6 in)
Width	465 mm (18.3 in)
Length	500 mm (19.7 in)

## Environmental Characteristics

**Table 1-21: Environmental characteristics**

Characteristics	Description
Temperature	
Operating	+10 °C to +40 °C
Non-operating	-20 °C to +60 °C
Relative humidity	
Operating	5% to 80% (no condensation) Maximum wet-bulb temperature 29 °C
Non-operating	5% to 90% (no condensation) Maximum wet-bulb temperature 29 °C
Altitude	
Operating	Up to 3,000 m (approximately 10,000 feet) Maximum operating temperature decreases 1 °C each 300 m above 1.5 km
Non-operating	Up to 12,000 m (approximately 40,000 feet)
Dynamics	
Vibration	
Operating	2.65 m/s <sup>2</sup> rms (0.27 Grms), 5 Hz to 500 Hz, 10 min, three axes
Non-operating	22.3 m/s <sup>2</sup> rms (2.28 Grms), 5 Hz to 500 Hz, 10 min, three axes
Shock	
Non-operating	294 m/s <sup>2</sup> (30 G), half-sine, 11 ms duration
Installation requirements	
Power dissipation	560 W (600 VA maximum)
Surge current	30 A peak (25 °C) for ≤ 5 line cycles, after product has been turned off for at least 30 s.
Cooling clearance	
Top and bottom clearance	2 cm (0.8 in)
Side clearance	15 cm (5.9 in)
Rear clearance	7.5 cm (3.0 in)

## Certifications and Compliances

**Table 1-22: Certifications and compliances**

Category	Standards or description												
EC Declaration of Conformity - EMC	<p>Meets the intent of Directive 89.336/EEC for Electromagnetic Compatibility. Compliance was demonstrated to the following specifications as listed in the Official Journal of the European Communities:</p> <p>EN61326. EMC requirement for Class A electrical equipment for measurement, control and laboratory use. <sup>1,2</sup></p> <table border="0"> <tr> <td>IEC 61000-4-2</td> <td>Electrostatic discharge Immunity (Performance Criterion B)</td> </tr> <tr> <td>IEC 61000-4-3</td> <td>RF electromagnetic field Immunity (Performance Criterion A)</td> </tr> <tr> <td>IEC 61000-4-4</td> <td>Electrical fast transient / burst Immunity (Performance Criterion B)</td> </tr> <tr> <td>IEC 61000-4-5</td> <td>Power line surge Immunity (Performance Criterion B)</td> </tr> <tr> <td>IEC 61000-4-6</td> <td>Conducted RF Immunity (Performance Criterion A)</td> </tr> <tr> <td>IEC 61000-4-11</td> <td>Voltage dips and Interruptions (Performance Criterion B)</td> </tr> </table> <p>EN 61000-3-2. AC power line harmonic emissions</p> <p>EN 61000-3-3. Voltage changes, fluctuation, and flicker</p> <p><sup>1</sup> Emissions which exceed the levels required by this standard may occur when this equipment is connected to a test object.</p> <p><sup>2</sup> To ensure compliance to the standards listed above, attach only high quality shielded cables to this instrument. High quality shielded cables typically are braid and foil types that have low impedance connection to shielded connectors at both ends.</p>	IEC 61000-4-2	Electrostatic discharge Immunity (Performance Criterion B)	IEC 61000-4-3	RF electromagnetic field Immunity (Performance Criterion A)	IEC 61000-4-4	Electrical fast transient / burst Immunity (Performance Criterion B)	IEC 61000-4-5	Power line surge Immunity (Performance Criterion B)	IEC 61000-4-6	Conducted RF Immunity (Performance Criterion A)	IEC 61000-4-11	Voltage dips and Interruptions (Performance Criterion B)
IEC 61000-4-2	Electrostatic discharge Immunity (Performance Criterion B)												
IEC 61000-4-3	RF electromagnetic field Immunity (Performance Criterion A)												
IEC 61000-4-4	Electrical fast transient / burst Immunity (Performance Criterion B)												
IEC 61000-4-5	Power line surge Immunity (Performance Criterion B)												
IEC 61000-4-6	Conducted RF Immunity (Performance Criterion A)												
IEC 61000-4-11	Voltage dips and Interruptions (Performance Criterion B)												
Australia/New Zealand Declaration of Conformity - EMC	<p>Complies with EMC provision of Radio Communications Act per the following standard(s):</p> <p>AS/NZS 2064.1/2, Industrial, Scientific, and Medical Equipment: 1992</p>												
EC Declaration of Conformity - Low Voltage	<p>Compliance was demonstrated to the following specification as listed in the Official Journal of the European Communities:</p> <p>Low Voltage Directive 73/23/EEC, amended by 93/68/EEC.</p> <table border="0"> <tr> <td>EN 61010-1:2001</td> <td>Safety requirements for electrical equipment for measurement, control, and laboratory use.</td> </tr> </table>	EN 61010-1:2001	Safety requirements for electrical equipment for measurement, control, and laboratory use.										
EN 61010-1:2001	Safety requirements for electrical equipment for measurement, control, and laboratory use.												
U.S. Nationally Recognized Testing Laboratory Listing	<table border="0"> <tr> <td>UL61010-01:2004, 2nd Edition</td> <td>Standard for electrical measuring and test equipment.</td> </tr> </table>	UL61010-01:2004, 2nd Edition	Standard for electrical measuring and test equipment.										
UL61010-01:2004, 2nd Edition	Standard for electrical measuring and test equipment.												
Canadian Certification	<table border="0"> <tr> <td>CAN/CSA C22.2 No. 61010-1:2004</td> <td>Safety requirement for electrical equipment for measurement, control, and laboratory use. Part 1.</td> </tr> </table>	CAN/CSA C22.2 No. 61010-1:2004	Safety requirement for electrical equipment for measurement, control, and laboratory use. Part 1.										
CAN/CSA C22.2 No. 61010-1:2004	Safety requirement for electrical equipment for measurement, control, and laboratory use. Part 1.												
Additional Compliance	<table border="0"> <tr> <td>IEC 61010-1:2001</td> <td>Safety requirements for electrical equipment for measurement, control, and laboratory use.</td> </tr> </table>	IEC 61010-1:2001	Safety requirements for electrical equipment for measurement, control, and laboratory use.										
IEC 61010-1:2001	Safety requirements for electrical equipment for measurement, control, and laboratory use.												

**Table 1-22: Certifications and compliances (Cont.)**

Category	Standards or description
Safety	<p>Complies with the following safety standards/regulations:</p> <p>UL 61010-1                      Standard for Electrical Measuring and Test Equipment.</p> <p>CAN/CSA C22.2 No.61010-1-04   Safety Requirements for Electrical Equipment for Measurement, Control, and Laboratory Use.</p> <p>EN 61010-1:2001                      Safety Requirements for Electrical Equipment for Measurement, Control, and Laboratory Use.</p>
Installation (Overvoltage) Category	<p>Terminals on this product may have different installation (overvoltage) category designations. The installation categories are:</p> <p>CAT III      Distribution-level mains (usually permanently connected). Equipment at this level is typically in a fixed industrial location.</p> <p>CAT II      Local-level mains (wall sockets). Equipment at this level includes appliances, portable tools, and similar products. Equipment is usually cord-connected.</p> <p>CAT I      Secondary (signal level) or battery operated circuits of electronic equipment.</p>
Overvoltage Category	Overvoltage Category II (as defined in IEC 61010-1)
Pollution Degree Descriptions	<p>A measure of the contaminates that could occur in the environment around and within a product. Typically the internal environment inside a product is considered to be the same as the external. Products should be used only in the environment for which they are rated.</p> <p>Pollution Degree 1      No pollution or only dry, nonconductive pollution occurs. Products in this category are generally encapsulated, hermetically sealed, or located in clean rooms.</p> <p>Pollution Degree 2      Normally only dry, nonconductive pollution occurs. Occasionally a temporary conductivity that is caused by condensation must be expected. This location is a typical office/home environment. Temporary condensation occurs only when the product is out of service.</p> <p>Pollution Degree 3      Conductive pollution, or dry, nonconductive pollution that becomes conductive due to condensation. These are sheltered locations where neither temperature nor humidity is controlled. The area is protected from direct sunshine, rain, or direct wind.</p>
Pollution Degree	Pollution Degree 2 (as defined in IEC 61010-1). Note: Rated for indoor use only.
Equipment Type	Test and measuring equipment
Safety Class	Class 1 - grounded product







# Performance Verification



# Performance Verification Procedures

Two types of performance verification procedures can be performed on the instrument: *Brief Procedures* and *Performance Tests*. You may not need to perform all of these procedures, depending on what you want to accomplish.

- To rapidly confirm that the instrument functions and was adjusted properly, perform *Diagnostics* and *Calibration* beginning on page 2-3.

**Advantages:** These procedures are quick to do and require no external equipment or signal sources. These procedures perform extensive functional and accuracy testing to provide high confidence that the instrument will perform properly.

- To further check functionality, first perform *Diagnostics* and *Calibration*, and then perform *Functional Test* beginning on page 2-5.

**Advantages:** The procedure requires minimal additional time to perform, and requires minimal equipment. The procedure can be used when the instrument is first received.

- If more extensive confirmation of performance is desired, complete the self tests and functional test, and then do the *Performance Tests* beginning on page 2-9.

**Advantages:** These procedures add direct checking of warranted specifications. These procedures require suitable test equipment and more time to execute (refer to *Equipment Required* on page 2-9).

If you are not familiar with operating this instrument, refer to the online help or the user information supplied with the instrument.



# Brief Procedures

There are three procedures in this section that provide a quick way to confirm basic functionality and proper adjustment:

- *Diagnostics*
- *Calibration*
- *Functional Test*

## Diagnostics

The following steps run the internal routines that confirm basic functionality and proper adjustment.

<b>Equipment</b>	None
<b>Prerequisites</b>	None

1. Disconnect all the cables from the output channels.
2. Select **System > Diagnostics** to open the **Diagnostics** dialog box. See Figure 2-1 on page 2-4.

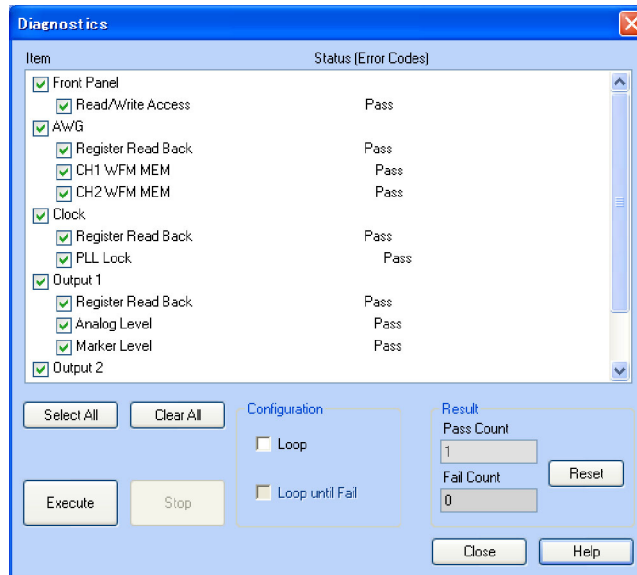

**Figure 2-1: Diagnostics dialog box**

3. In the Diagnostics dialog box, confirm that all the check boxes are selected. If they are not all selected, click the **Select All** button.
4. Click the **Execute** button to execute the diagnostics.

The internal diagnostics perform an exhaustive verification of proper instrument function. This verification may take several minutes. When the verification is completed, the resulting status will appear in the dialog box.

5. Verify that **Pass** appears as Status in the dialog box when the diagnostics complete.
6. Click the close button to close the dialog box.

## Calibration

<b>Equipment</b>	None
<b>Prerequisites</b>	Power on the instrument and allow a 20 minute warm-up before doing this procedure.

1. Select **System > Calibration** to open the **Calibration** dialog box. See Figure 2-2.

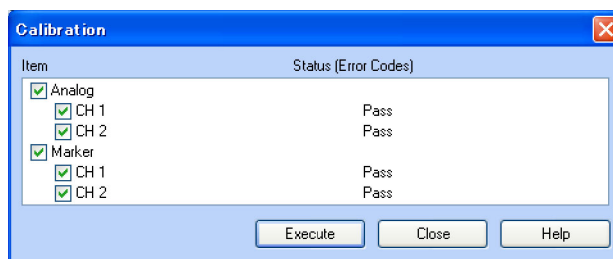

**Figure 2-2: Calibration dialog box**

2. Click the **Execute** button to start the routine.
3. Verify that **Pass** appears in the status column for all items when the calibration completes.
4. Click the close button to close the dialog box.

## Functional Test

The purpose of the procedure is to confirm that the instrument functions properly. The equipment required is SMA cables, SMA terminators, SMA female to BNC male adapters, and an oscilloscope.

### Checking the Analog and Marker Outputs

<b>Equipment required</b>	Oscilloscope (TDS5054B or equivalent) Three 50 $\Omega$ SMA cables Three 50 $\Omega$ SMA terminators Three SMA female to BNC male adapters
<b>Prerequisites</b>	None

1. Press the **All Outputs On/Off** button on the AWG7000 to turn off all the outputs.
2. Use a 50  $\Omega$  SMA cable and a SMA female to BNC male adapter to connect the Channel 1 Analog connector on the AWG7000 to the CH1 connector on the oscilloscope. See Figure 2-3 on page 2-6.
3. Use a 50  $\Omega$  SMA cable and a SMA female to BNC male adapter to connect the Channel 1 Mkr 1 connector on the AWG7000 to the CH2 connector on the oscilloscope. See Figure 2-3 on page 2-6.

4. Use the 50  $\Omega$  SMA cable and the SMA female to BNC male adapter to connect the Channel 1 Mkr 2 connector on the AWG7000 to the CH3 connector on the oscilloscope. See Figure 2-3.
5. Use a 50  $\Omega$  SMA terminator to terminate the Channel 1 Analog connector on the AWG7000. See Figure 2-3.
6. Use a 50  $\Omega$  SMA terminator to terminate the Channel 1 Mkr 1 connector on the AWG7000. See Figure 2-3.
7. Use the 50  $\Omega$  SMA terminator to terminate the Channel 1 Mkr 2 connector on the AWG7000. See Figure 2-3.

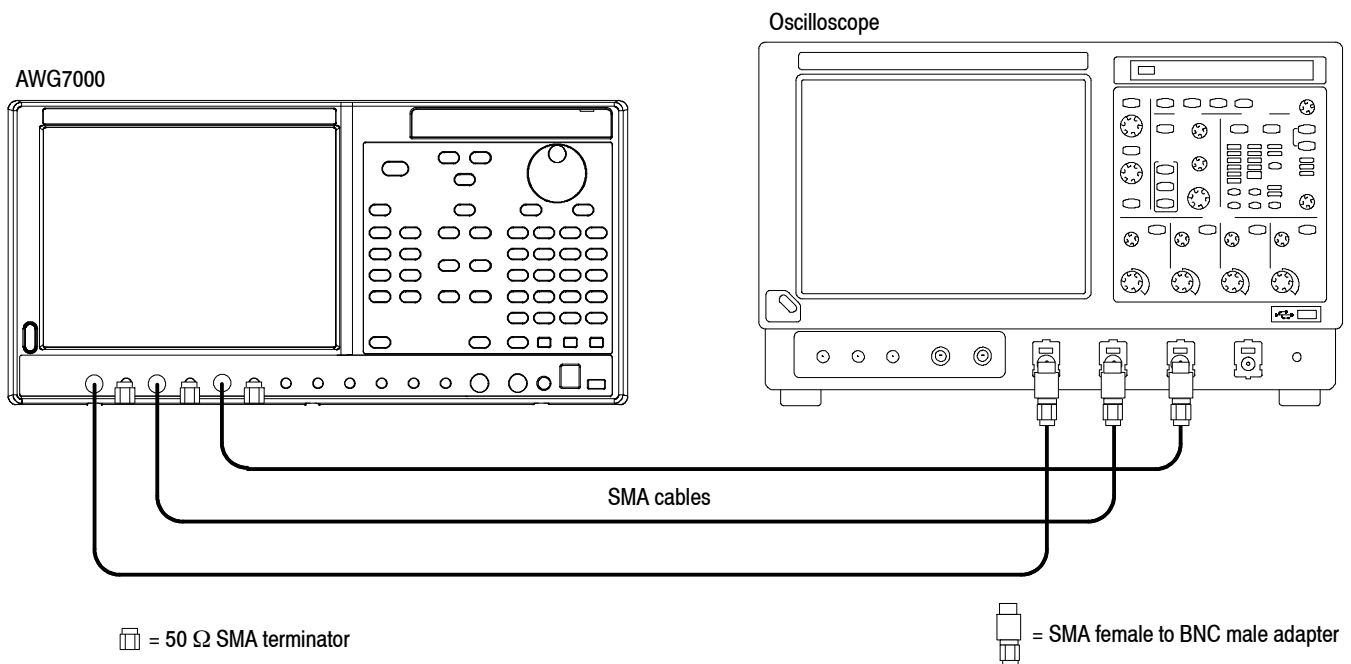
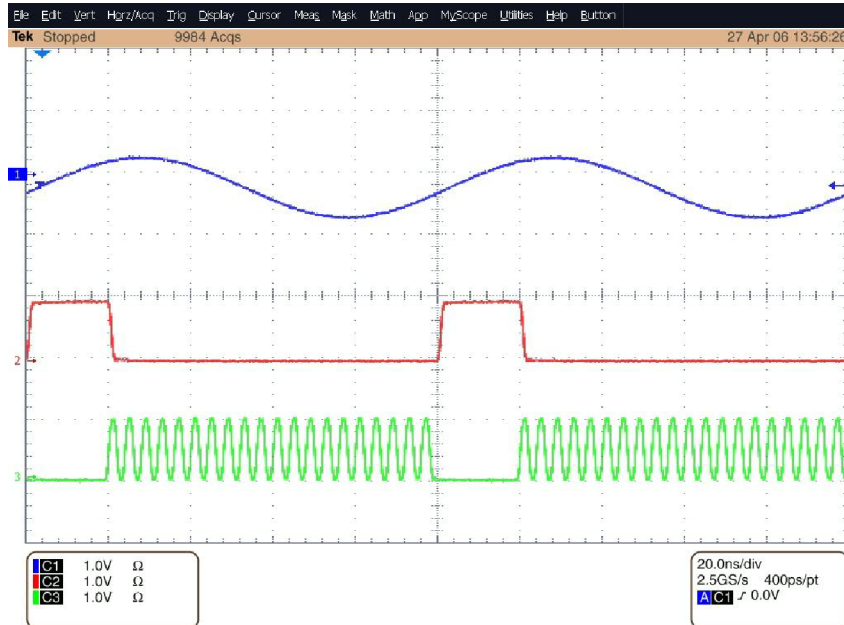

**Figure 2-3: Equipment connections for checking the analog and marker outputs**





14. Check that the Channel 1 Analog, Mkr 1, and Mkr 2 waveforms are properly displayed on the oscilloscope screen as shown in Figure 2-4.



**Figure 2-4: Output waveform from the Analog, Mkr1, and Mkr 2 connectors**

15. Press the **Ch 1 On** button again to disable the channel 1 output.
16. *For the AWG7102 or AWG7052:* Repeat the test for the Channel 2 Analog, Mkr 1, and Mkr 2 outputs.

# Performance Tests

This section contains performance verification procedures for the specifications marked with the ✓ symbol.

## Prerequisites

The tests in this section comprise an extensive, valid confirmation of performance and functionality when the following requirements are met:

- The cabinet must be installed on the instrument.
- You must have performed and passed the procedure *Diagnostics* and *Calibration* beginning on page 2-3, and the procedure *Functional Tests* beginning on page 2-5.
- The instrument must have been last adjusted at an ambient temperature between +20 °C and +30 °C, must have been operating for a warm-up period of at least 20 minutes, and must be operating at an ambient temperatures between +10 °C and +40 °C.

## Equipment Required

Table 2-1 lists the test equipment required to perform all of the performance verification procedure. The table identifies examples of recommended equipment and lists the required precision where applicable. If you substitute other test equipment for the listed examples, the equipment must meet or exceed the listed tolerances.

**Table 2-1: Equipment required**

Item	Qty.	Minimum requirements	Recommended equipment
Frequency counter	1 ea.	Frequency accuracy: within $\pm 0.01$ ppm	Agilent Technologies 53181A
Sampling oscilloscope	1 ea.	Bandwidth: 20 GHz or higher 2 channels	Tektronix CSA8200 with 80E03
Spectrum analyzer	1 ea.	Bandwidth: DC to 8 GHz	Tektronix RSA3308A
Digital multimeter	1 ea.	DC accuracy: within $\pm 0.01\%$	Keithley 2000 DMM
50 $\Omega$ BNC cable	1 ea.	DC to 2 GHz	Tektronix part number 012-0057-01
50 $\Omega$ SMA cable	2 ea.	DC to 20 GHz	Tensolite 1-3636-465-5236
50 $\Omega$ SMA terminator	2 ea.	DC to 18 GHz	Tektronix part number 015-1022-01 (supplied with the AWG7000)
50 $\Omega$ BNC terminator	1 ea.	DC to 1 GHz, feedthrough	Tektronix part number 011-0049-02

**Table 2-1: Equipment required (Cont.)**

Item	Qty.	Minimum requirements	Recommended equipment
50 $\Omega$ SMA attenuator	2 ea.	5 X, 14 dB, DC to 18 GHz	Tektronix part number 015-1002-01
SMA-BNC adapter	1 ea.	SMA male to BNC female connectors	Tektronix part number 015-0554-00
SMA-N adapter	1 ea.	SMA female to N male connectors	Tensolite 5004CCSF
BNC-dual banana adapter	1 ea.	BNC to dual banana plugs	Tektronix part number 103-0090-00
DC output lead set	1 ea.	8-pin twisted pair, 24 inch	Tektronix part number 012-1697-00 (supplied with the AWG7000)

**Test Waveforms**

Table 2-2 lists the test waveforms that are used for the performance verification procedures and functional test. These are included in the pv\_awg7000.awg file on the C: drive.

**Table 2-2: Test waveforms**

No.	Waveform name	Purpose
1	dc_minus	For checking the analog amplitude accuracy
2	dc_plus	For checking the analog amplitude accuracy
3	dc_zero	For checking the analog offset accuracy
4	marker_hi	For checking the marker high level accuracy
5	marker_low	For checking the marker low level accuracy
6	sine32	For checking analog harmonic distortion, analog non-harmonic spurious signal, and analog phase noise
7	sine_mk1_mk2	For the functional test (refer to page 2-5)
8	square1	For checking the marker output delay accuracy test

**NOTE.** If your instrument is the AWG7051 or AWG7052, a warning message is displayed when you open the pv\_awg7000.awg file. Press the OK button.

## Test Record

Photocopy this page and the next eight pages, and use them to record the performance test results for your instrument.

### AWG7000 Series Performance Test Record

Instrument Model:       AWG7101                       AWG7102                       AWG7051                       AWG7052  
 Instrument Serial Number: \_\_\_\_\_ Certificate Number: \_\_\_\_\_  
 Temperature: \_\_\_\_\_ RH %: \_\_\_\_\_  
 Date of Calibration: \_\_\_\_\_ Technician: \_\_\_\_\_

Performance Test		Minimum	Incoming	Outgoing	Maximum
<i>10 MHz Reference Frequency Accuracy</i>		9.99998 MHz			10.00002 MHz
<i>Analog Offset Accuracy</i>					
AWG7000 standard					
Ch 1	Offset:				
	+0.5 V	480 mV			520 mV
	0.0 V	-10 mV			+10 mV
	-0.5 V	-520 mV			- 480 mV
<u>Ch 1</u>	Offset:				
	+0.5 V	480 mV			520 mV
	0.0 V	-10 mV			+10 mV
	-0.5 V	-520 mV			- 480 mV
Ch 2	Offset:				
	+0.5 V	480 mV			520 mV
	0.0 V	-10 mV			+10 mV
	-0.5 V	-520 mV			- 480 mV
<u>Ch 2</u>	Offset:				
	+0.5 V	480 mV			520 mV
	0.0 V	-10 mV			+10 mV
	-0.5 V	-520 mV			- 480 mV
AWG7000 Option 02					
Ch 1	Offset:				
	N/A (0V)	-10 mV			+10 mV
<u>Ch 1</u>	Offset:				
	N/A (0V)	-10 mV			+10 mV
Ch 2	Offset:				
	N/A (0V)	-10 mV			+10 mV
<u>Ch 2</u>	Offset:				
	N/A (0V)	-10 mV			+10 mV

## AWG7000 Series Performance Test Record (Cont.)

Performance Test		Minimum	Incoming	Outgoing	Maximum
AWG7102 Option 06					
Ch 1	Offset				
	N/A (0 V)	-10 mV			10 mV
Ch 1	Offset				
	N/A (0 V)	-10 mV			10 mV
Ch 2	Offset				
	N/A (0 V)	-10 mV			10 mV
Ch 2	Offset				
	N/A (0 V)	-10 mV			10 mV
Interleave	Offset	Output mode			
	N/A (0 V)	Interleave: On	-10 mV		10 mV
<i>Analog Amplitude Accuracy</i>					
AWG7000 standard					
Ch1	Amplitude	Output mode			
	50 mVp-p	Direct D/A out: Off	46.5 mV		53.5 mV
	200 mVp-p	Direct D/A out: Off	192 mV		208 mV
	500 mVp-p	Direct D/A out: Off	483 mV		517 mV
	1.0 Vp-p	Direct D/A/out: Off	0.968 V		1.032 V
	2.0 Vp-p	Direct D/A/out: Off	1.938 V		2.062 V
	50 mVp-p	Direct D/A out: On	46.5 mV		53.5 mV
	200 mVp-p	Direct D/A out: On	192 mV		208 mV
	1.0 Vp-p	Direct D/A out: On	0.968 V		1.032 V
Ch1	Amplitude	Output mode			
	50 mVp-p	Direct D/A out: Off	46.5 mV		53.5 mV
	200 mVp-p	Direct D/A out: Off	192 mV		208 mV
	500 mVp-p	Direct D/A out: Off	483 mV		517 mV
	1.0 Vp-p	Direct D/A/out: Off	0.968 V		1.032 V
	2.0 Vp-p	Direct D/A/out: Off	1.938 V		2.062 V
	50 mVp-p	Direct D/A out: On	46.5 mV		53.5 mV
	200 mVp-p	Direct D/A out: On	192 mV		208 mV
	1.0V p-p	Direct D/A out: On	0.968 V		1.032 V

## AWG7000 Series Performance Test Record (Cont.)

Performance Test		Minimum	Incoming	Outgoing	Maximum
Ch2	Amplitude	Output mode			
	50 mVp-p	Direct D/A out: Off	46.5 mV		53.5 mV
	200 mVp-p	Direct D/A out: Off	192 mV		208 mV
	500 mVp-p	Direct D/A out: Off	483 mV		517 mV
	1.0 Vp-p	Direct D/A/out: Off	0.968 V		1.032 V
	2.0 Vp-p	Direct D/A/out: Off	1.938 V		2.062 V
	50 mVp-p	Direct D/A out: On	46.5 mV		53.5 mV
	200 mVp-p	Direct D/A out: On	192 mV		208 mV
	1.0 Vp-p	Direct D/A out: On	0.968 V		1.032 V
Ch2	Amplitude	Output mode			
	50 mVp-p	Direct D/A out: Off	46.5 mV		53.5 mV
	200 mVp-p	Direct D/A out: Off	192 mV		208 mV
	500 mVp-p	Direct D/A out: Off	483 mV		517 mV
	1.0 Vp-p	Direct D/A/out: Off	0.968 V		1.032 V
	2.0 Vp-p	Direct D/A/out: Off	1.938 V		2.062 V
	50 mVp-p	Direct D/A out: On	46.5 mV		53.5 mV
	200 mVp-p	Direct D/A out: On	192 mV		208 mV
	1.0 Vp-p	Direct D/A out: On	0.968 V		1.032 V
AWG7000 Option 02					
Ch 1	Amplitude:				
	500 mVp-p		488 mV		512 mV
	1.0 Vp-p		0.978 V		1.022 V
Ch 1	Amplitude:				
	500 mVp-p		488 mV		512 mV
	1.0 Vp-p		0.978 V		1.022 V
Ch 2	Amplitude:				
	500 mVp-p		488 mV		512 mV
	1.0 Vp-p		0.978 V		1.022 V
Ch 2	Amplitude:				
	500 mVp-p		488 mV		512 mV
	1.0 Vp-p		0.978 V		1.022 V

## AWG7000 Series Performance Test Record (Cont.)

Performance Test		Minimum	Incoming	Outgoing	Maximum
AWG7102 Option 06					
Ch 1	Amplitude				
	500 mVp-p	488 mV			512 mV
	1.0 Vp-p	0.978 mV			1.022 mV
Ch 1	Amplitude				
	500 mVp-p	488 mV			512 mV
	1.0 Vp-p	0.978 mV			1.022 mV
Ch 2	Amplitude				
	500 mVp-p	488 mV			512 mV
	1.0 Vp-p	0.978 mV			1.022 mV
Ch 2	Amplitude				
	500 mVp-p	488 mV			512 mV
	1.0 Vp-p	0.978 mV			1.022 mV
<b>Analog Harmonic Distortion</b>					
AWG710x standard					
Ch 1	Amplitude	Output mode			
	1.0 V	Direct D/A out: Off	none		-35 dBc
	1.0 V	Direct D/A out: On	none		-42 dBc
Ch 2	Amplitude	Output mode			
	1.0 V	Direct D/A out: Off	none		-35 dBc
	1.0 V	Direct D/A out: On	none		-42 dBc
AWG705x standard					
Ch 1	Amplitude	Output mode			
	1.0 V	Direct D/A out: Off	none		-40 dBc
	1.0 V	Direct D/A out: On	none		-45 dBc
Ch 2	Amplitude	Output mode			
	1.0 V	Direct D/A out: Off	none		-40 dBc
	1.0 V	Direct D/A out: On	none		-45 dBc
AWG7101 Option 02					
Ch 1	Amplitude				
	1.0 V	none			-42 dBc
AWG705x Option 02					
Ch 1	Amplitude				
	1.0 V	none			-45 dBc
Ch 2	Amplitude				
	1.0 V	none			-45 dBc



## AWG7000 Series Performance Test Record (Cont.)

Performance Test		Minimum	Incoming	Outgoing	Maximum
<i>AWG7102 Option 06</i>					
Ch 1	Amplitude				
	1.0 V	none			-42 dBc
Ch 2	Amplitude				
	1.0 V	none			-42 dBc
<i>Analog Non-Harmonic Spurious</i>					
<i>AWG7000 standard</i>					
Ch1	Amplitude	Output mode			
	1.0 V	Direct D/A out: Off	none		-50 dBc
	1.0 V	Direct D/A out: On	none		-50 dBc
Ch 2	Amplitude	Output mode			
	1.0 V	Direct D/A out: Off	none		-50 dBc
	1.0 V	Direct D/A out: On	none		-50 dBc
<i>AWG7000 Option 02</i>					
Ch 1	Amplitude				
	1.0 V	none			-50 dBc
Ch 2	Amplitude				
	1.0 V	none			-50 dBc
<i>AWG7102 Option 06</i>					
Ch 1	Amplitude				
	1.0 V	none			-50 dBc
Ch 2	Amplitude				
	1.0 V	none			-50 dBc

## AWG7000 Series Performance Test Record (Cont.)

Performance Test			Minimum	Incoming	Outgoing	Maximum
<i>Analog Phase Noise (at 10 kHz offset)</i>						
AWG7000						
Ch 1	Amplitude	Output mode				
	1.0 V	Direct D/A out: Off	none			-90 dBc/Hz
	1.0 V	Direct D/A out: On	none			-90 dBc/Hz
Ch 2	Amplitude	Output mode				
	1.0 V	Direct D/A out: Off	none			-90 dBc/Hz
	1.0 V	Direct D/A out: On	none			-90 dBc/Hz
AWG7000 Option 02						
Ch 1	Amplitude					
	1.0 V		none			-90 dBc/Hz
Ch 2	Amplitude					
	1.0 V		none			-90 dBc/Hz
AWG7102 Option 06						
Ch 1	Amplitude					
	1.0 V		none			-90 dBc/Hz
Ch 2	Amplitude					
	1.0 V		none			-90 dBc/Hz
Interleave	Amplitude	Output mode				
	0.5 V	Interleave: On Zeroing: On	none			-85 dBc/Hz
	1.0 V	Interleave: On Zeroing: Off	none			-85 dBc/Hz

## AWG7000 Series Performance Test Record (Cont.)

Performance Test			Minimum	Incoming	Outgoing	Maximum
<i>Marker High and Low Level Accuracy</i>						
AWG7000						
Ch 1	Mkr 1	High level setting				
		+1.4 V	1.21 V			1.59 V
		0.0 V	-50 mV			+50 mV
		-0.9 V	-1.04 V			-0.76 V
		Low level setting				
		+0.9 V	0.76 V			1.04 V
		0.0 V	-50 mV			+50 mV
		-1.4 V	-1.59 V			-1.21 V
	<u>Mkr 1</u>	High level setting				
		+1.4 V	1.21 V			1.59 V
		0.0 V	-50 mV			+50 mV
		-0.9 V	-1.04 V			-0.76 V
		Low level setting				
		+0.9 V	0.76 V			1.04 V
		0.0 V	-50 mV			+50 mV
		-1.4 V	-1.59 V			-1.21 V
	Mkr 2	High level setting				
		+1.4 V	1.21 V			1.59 V
		0.0 V	-50 mV			+50 mV
		-0.9 V	-1.04 V			-0.76 V
		Low level setting				
		+0.9 V	0.76 V			1.04 V
		0.0 V	-50 mV			+50 mV
		-1.4 V	-1.59 V			-1.21 V
	<u>Mkr 2</u>	High level setting				
		+1.4 V	1.21 V			1.59 V
		0.0 V	-50 mV			+50 mV
		-0.9 V	-1.04 V			-0.76 V
		Low level setting				
		+0.9 V	0.76 V			1.04 V
		0.0 V	-50 mV			+50 mV
		-1.4 V	-1.59 V			-1.21 V

## AWG7000 Series Performance Test Record (Cont.)

Performance Test			Minimum	Incoming	Outgoing	Maximum
Ch 2	Mkr 1	High level setting				
		+1.4 V	1.21 V			1.59 V
		0.0 V	-50 mV			+50 mV
		-0.9 V	-1.04 V			-0.76 V
		Low level setting				
		+0.9 V	0.76 V			1.04 V
		0.0 V	-50 mV			+50 mV
	-1.4 V	-1.59 V			-1.21 V	
	Mkr 1	High level setting				
		+1.4 V	1.21 V			1.59 V
		0.0 V	-50 mV			+50 mV
		-0.9 V	-1.04 V			-0.76 V
		Low level setting				
		+0.9 V	0.76 V			1.04 V
0.0 V		-50 mV			+50 mV	
-1.4 V	-1.59 V			-1.21 V		
Mkr 2	High level setting					
	+1.4 V	1.21 V			1.59 V	
	0.0 V	-50 mV			+50 mV	
	-0.9 V	-1.04 V			-0.76 V	
	Low level setting					
	+0.9 V	0.76 V			1.04 V	
	0.0 V	-50 mV			+50 mV	
-1.4 V	-1.59 V			-1.21 V		
Mkr 2	High level setting					
	+1.4 V	1.21 V			1.59 V	
	0.0 V	-50 mV			+50 mV	
	-0.9 V	-1.04 V			-0.76 V	
	Low level setting					
	+0.9 V	0.76 V			1.04 V	
	0.0 V	-50 mV			+50 mV	
-1.4 V	-1.59 V			-1.21 V		

**AWG7000 Series Performance Test Record (Cont.)**

Performance Test		Minimum	Incoming	Outgoing	Maximum
<i>Marker Output Delay Accuracy</i>					
AWG7000					
Ch 1	Mkr 1	92.5 ps			207.5 ps
	Mkr 2	92.5 ps			207.5 ps
Ch 2	Mkr 1	92.5 ps			207.5 ps
	Mkr 2	92.5 ps			207.5 ps
<i>DC Output Accuracy</i>					
AWG7000					
DC output:					
+5 V		4.77 V			5.23 V
+3 V		2.83 V			3.17 V
0.0 V		-80 mV			+80 mV
-3 V		-3.17 V			-2.83 V

## 10 MHz Reference Frequency Accuracy

<b>Equipment required</b>	Frequency counter 50 $\Omega$ BNC cable
<b>Prerequisites</b>	As listed under <i>Prerequisites</i> on page 2-9.

1. Use the 50  $\Omega$  BNC cable to connect the 10 MHz Reference Output connector on the AWG7000 to the frequency counter CH1 input. See Figure 2-5.

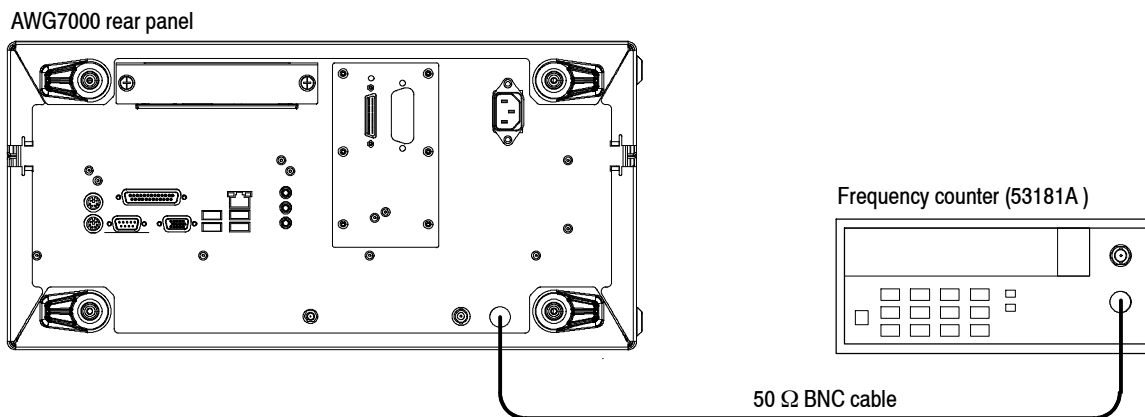

**Figure 2-5: Equipment connection for verifying the 10 MHz reference frequency accuracy**

2. Set the frequency counter settings as indicated below:
  - MEASURE . . . . . Frequency1
  - Gate Time: 0.10 s
  - CHANNEL1 . . . . . Coupling: AC
  - Impedance: 50  $\Omega$
3. Press the **Factory Default** button on the AWG7000.
4. Verify that the frequency counter reading falls within the range of 9.99998 MHz to 10.00002 MHz ( $\pm 0.2$  ppm).
5. Disconnect the test setup.

## Analog Offset Accuracy

<b>Equipment required</b>	Digital multimeter 50 $\Omega$ BNC cable SMA-BNC adapter 50 $\Omega$ BNC terminator BNC-dual banana adapter 50 $\Omega$ SMA terminator
<b>Prerequisites</b>	As listed under <i>Prerequisites</i> on page 2-9.

### Measuring the Terminator Resistance

Before verifying the analog offset accuracy, you need to measure the resistance of the 50  $\Omega$  BNC terminator.

1. Connect the BNC-dual banana adapter and 50  $\Omega$  BNC terminator to the HI and LO inputs on the digital multimeter. See Figure 2-6.

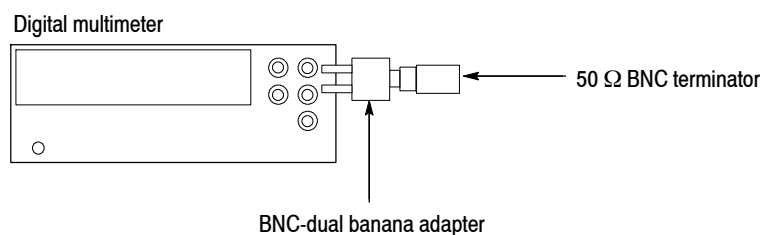
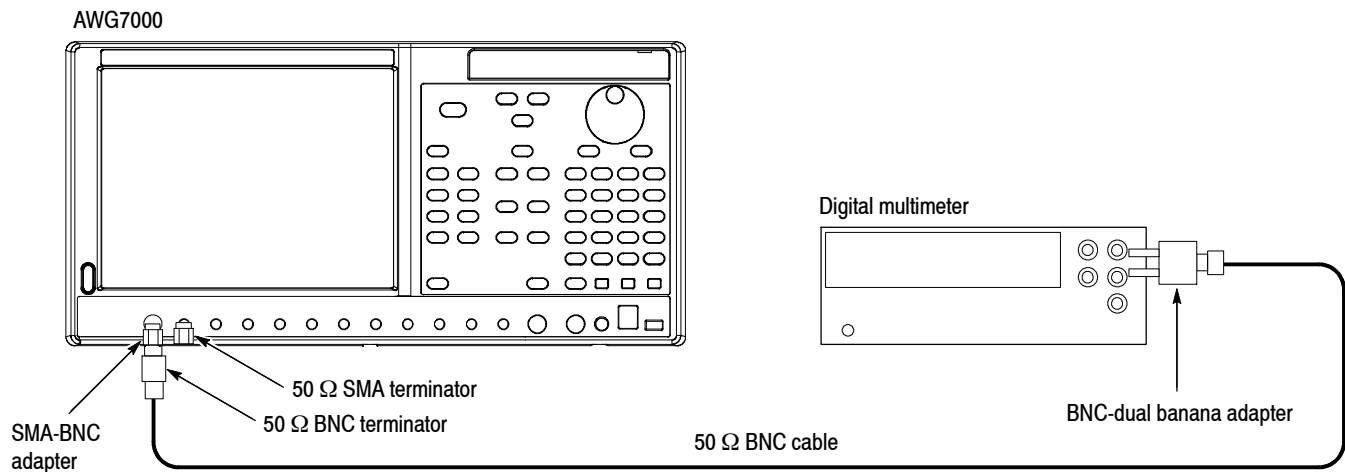

**Figure 2-6: Equipment connection for measuring the terminator resistance**

2. Set the digital multimeter to the  **$\Omega$  2 wires** mode.
3. Measure the resistance and note the value as **Term\_R**.
4. Set the digital multimeter to the **VDC** mode.
5. Disconnect the test setup.

### Verifying the Analog Offset Accuracy

1. Press the **All Outputs On/Off** button on the AWG7000 to turn off all the outputs.
2. Use the 50  $\Omega$  BNC cable, SMA-BNC adapter, 50  $\Omega$  BNC terminator, and BNC-Banana adapter to connect the Channel 1 Analog connector on the AWG7000 to the HI and LO inputs on the digital multimeter. See Figure 2-7.
3. Use the 50  $\Omega$  SMA terminator to terminate the Channel 1 Analog connector on the AWG7000. See Figure 2-7.



**Figure 2-7: Equipment connection for verifying the analog offset accuracy**

4. Press the **Factory Default** button on the AWG7000.
5. Press the **Ch1 Select** button on the AWG7000.
6. On the AWG7000, load the **dc\_zero** waveform as an output waveform.
  - a. Press the **File Open** button or select **File > Open File** to open the Open dialog box.
  - b. In the dialog box, navigate to the **C:\Program Files\Tektronix\AWG\System\PV** directory, and then select the **pv\_awg7000.awg** file. The **Waveform List** window appears.
  - c. In the window, select (drag and drop) the **dc\_zero** waveform on the **User Defined** tab.
7. Press the **Ch 1 On** button on the AWG7000 to enable the channel 1 output.
8. Press the **Run** button on the AWG7000 to output the waveform.



9. Set the offset of the AWG7000 to the level shown in the first row (or the corresponding row for your instrument) of Table 2-3.

**Table 2-3: Analog offset accuracy**

Model	Offset settings	Accuracy limits
AWG7000	+0.5 V	480 mV to 520 mV
	0.0 V	-10 mV to +10 mV
	-0.5 V	-520 mV to -480 mV
AWG7000 Option 02	N/A (0 V)	-10 mV to + 10 mV
AWG7000 Option 06	N/A (0 V)	-10 mV to +10 mV

10. Measure the output voltage on the digital multimeter and note the value as **Measured\_voltage**.
11. Use the following formula to compensate the voltage for the 50  $\Omega$  BNC terminator:
- $$\text{Voltage} = [(\text{Term\_R} + 50) / (2 \times \text{Term\_R})] \times \text{Measured\_voltage}$$
- Where Term\_R is the resistance of the 50  $\Omega$  BNC terminator measured in step 3.
12. Verify that the calculated value falls within the limits given in Table 2-3.
13. Repeat steps 9 through 12 for each offset setting in Table 2-3.
14. Move the SMA-BNC adapter from the Channel 1 Analog connector to the Channel 1 Analog connector and move the 50  $\Omega$  SMA terminator from the Channel 1 Analog connector to the Channel 1 Analog connector.
15. Repeat steps 9 through 13.
16. *For the AWG7102 or AWG7052:* Repeat steps 7 through 14 for the Channel 2 output.
17. Press the **All Outputs On/Off** button on the AWG7000 to turn off all the outputs.
18. Disconnect the test setup.

## Analog Amplitude Accuracy

<b>Equipment required</b>	Digital multimeter 50 $\Omega$ BNC cable SMA-BNC adapter 50 $\Omega$ BNC terminator BNC-dual banana adapter 50 $\Omega$ SMA terminator
<b>Prerequisites</b>	As listed under <i>Prerequisites</i> on page 2-9.

1. Perform *Measuring the Terminator Resistance* on page 2-21.
2. Press the **All Outputs On/Off** button on the AWG7000 to turn off all the outputs.
3. Use the 50  $\Omega$  BNC cable, SMA-BNC adapter, 50  $\Omega$  BNC terminator, and BNC-Banana adapter to connect the Channel 1 Analog connector on the AWG7000 to the HI and LO inputs on the digital multimeter. See Figure 2-7 on page 2-22.
4. Use the 50  $\Omega$  SMA terminator to terminate the Channel 1 Analog connector on the AWG7000. See Figure 2-7 on page 2-22.
5. Press the **Factory Default** button on the AWG7000.
6. Press the **Ch 1 Select** button on the AWG7000.
7. On the AWG7000, load the **dc\_plus** waveform as an output waveform.
  - a. Press the **File Open** button or select **File > Open File** to open the Open dialog box.
  - b. In the dialog box, navigate to the **C:\Program Files\Tektronix\AWG\System\PV** directory, and then select the **pv\_awg7000.awg** file. The **Waveform List** window appears.
  - c. In the window, select (drag and drop) the **dc\_plus** waveform on the **User Defined** tab.
8. Press the **Ch 1 On** button on the AWG7000 to enable the channel 1 output.
9. Press the **Run** button on the AWG7000 to output the waveform.
10. Set the the amplitude and output mode of the AWG7000 as shown in the first row (or the corresponding row for your instrument) of Table 2-4.

**Table 2-4: Analog amplitude accuracy**

Model	Amplitude settings	Output mode settings	Accuracy limits
AWG7000	50 mVp-p	-----	46.5 mV to 53.5 mV
	200 mVp-p	-----	192 mV to 208 mV
	500 mVp-p	-----	483 mV to 517 mV
	1.0 Vp-p	-----	0.968 V to 1.032 V
	2.0 Vp-p	-----	1.938 V to 2.062 V
	50 mVp-p	Direct D/A out: On	46.5 mV to 53.5 mV
	200 mVp-p	Direct D/A out: On	192 mV to 208 mV
	1.0 Vp-p	Direct D/A out: On	0.968 V to 1.032 V
AWG7000 Option 02/ 06	500 mVp-p	Interleave: Off (Option 06)	488 mV to 512 mV
	1.0 Vp-p	Interleave: Off (Option 06)	0.978 V to 1.022 V

11. Measure the output voltage on the digital multimeter and note the value as **Measured\_voltage\_1**.
12. Use the following formula to compensate the voltage for the 50  $\Omega$  BNC terminator:
 
$$V_{\text{high}} = [(Term\_R + 50) / (2 \times Term\_R)] \times \text{Measured\_voltage\_1}$$
 Where Term\_R is the resistance of the 50  $\Omega$  BNC terminator measured in step 3 on page 2-21.
13. In the **Waveform List** window, select the **dc\_minus** waveform on the **User Defined** tab.
14. Measure the output voltage on the digital multimeter and note the value as **Measured\_voltage\_2**.
15. Use the following formula to compensate the voltage for the 50  $\Omega$  BNC terminator:
 
$$V_{\text{low}} = [(Term\_R + 50) / (2 \times Term\_R)] \times \text{Measured\_voltage\_2}$$
 Where Term\_R is the resistance of the 50  $\Omega$  BNC terminator measured in step 3 on page 2-21.
16. Verify that the voltage difference  $|(V_{\text{high}} - V_{\text{low}})|$  falls within the limits given in Table 2-4.
17. Repeat steps 7 through 16 for each amplitude setting in Table 2-4.

18. Move the SMA-BNC adapter from the Channel 1 Analog connector to the Channel 1 Analog connector and move the 50 Ω SMA terminator from the Channel 1 Analog connector to the Channel 1 Analog connector.
19. Repeat steps 10 through 17.
20. *For the AWG7102 or AWG7052:* Repeat steps 6 through 18 for the Channel 2 output.
21. Press the **All Outputs On/Off** button on the AWG7000 to turn off all the outputs.
22. Disconnect the test setup.

## Analog Harmonic Distortion

<b>Equipment required</b>	Spectrum analyzer 50 Ω SMA cable SMA-N adapter 50 Ω SMA terminator
<b>Prerequisites</b>	As listed under Prerequisites on page 2-9.

1. Press the **All Outputs On/Off** button on the AWG7000 to turn off all the outputs.
2. Use the 50 Ω SMA cable and SMA-N adapter to connect the Channel 1 Analog connector on the AWG7000 to the INPUT connector on the spectrum analyzer. See Figure 2-8.
3. Use the 50 Ω SMA terminator to terminate the Channel 1 Analog connector on the AWG7000. See Figure 2-8.

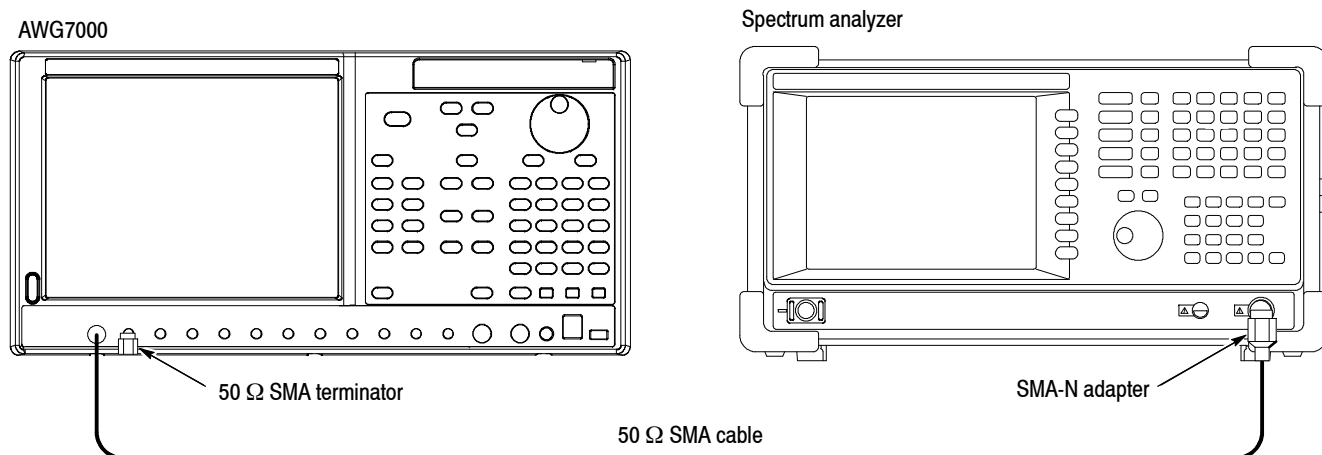

**Figure 2-8: Equipment connections for verifying the analog harmonic distortion**

4. Set the spectrum analyzer settings as indicated below:
 

Center frequency . . . . .	1.5 GHz
	2 GHz (for the AWG7102 Option 06,
	Interleave: On)
Span . . . . .	3 GHz
RBW . . . . .	1 MHz
5. Press the **Factory Default** button on the AWG7000.
6. Press the **Ch 1 Select** button on the AWG7000.
7. On the AWG7000, load the **sine\_32** waveform as an output waveform.
  - a. Press the **File Open** button or select **File > Open File** to open the Open dialog box.
  - b. In the dialog box, navigate to the **C:\Program Files\Tektronix\AWG\System\PV** directory, and then select the **pv\_awg7000.awg** file. The **Waveform List** window appears.
  - c. In the window, select (drag and drop) the **sine\_32** waveform on the **User Defined** tab.
8. Press the **Ch 1 On** button on the AWG7000 to enable the channel 1 output.
9. Press the **Run** button on the AWG7000 to output the waveform.
10. Make the AWG7000 settings shown in the first row (or corresponding row for your instrument) of Table 2-5 on page 2-28.

**Table 2-5: Analog harmonic distortion**

AWG7000 model and settings				Measurement frequency (MHz)				Accuracy Limit
Model	Output mode	Amplitude	Sampling rate (output frequency)	2nd	3rd	4th	5th	Nth reference
AWG710x	Direct out: Off	1.0 Vp-p	10 GS/s (312.5 MHz)	625	937.5	1250	1562.5	< -35 dBc
	Direct out: On							< -42 dBc
AWG7101 Option 02	-----	1.0 Vp-p	10 GS/s (312.5 MHz)	625	937.5	1250	1562.5	< -42 dBc
AWG7102 Option 06	Interleave: Off	1.0 Vp-p	10 GS/s (312.5 MHz)	625	937.5	1250	1562.5	< -42 dBc
AWG705x	Direct out: Off	1.0 Vp-p	5 GS/s (156.25 MHz)	312.5	468.75	625	781.25	< -40 dBc
	Direct out: On							< -45 dBc
AWG705x Option 02	-----	1.0 Vp-p	5GS/s (156.25 MHz)	312.5	468.75	625	781.25	< -45 dBc

11. Use the delta measurement function of the spectrum analyzer to measure harmonic distortion of each measurement frequency.
12. Verify that the harmonic distortion falls within the limits given in Table 2-5.
13. Repeat steps 10 through 12 for each setting in Table 2-5.
14. *For the AWG7102 or AWG7052:* Repeat the test for the Channel 2 output.
15. Press the **All Outputs On/Off** button on the AWG7000 to turn off all the outputs.
16. Disconnect the test setup.

## Analog Non-Harmonic Spurious Signal

<b>Equipment required</b>	Spectrum analyzer 50 $\Omega$ SMA cable SMA-N adapter 50 $\Omega$ SMA terminator
<b>Prerequisites</b>	As listed under Prerequisites on page 2-9.

1. Press the **All Outputs On/Off** button on the AWG7000 to turn off all the outputs.
2. Use the 50  $\Omega$  SMA cable and SMA-N adapter to connect the Channel 1 Analog connector on the AWG7000 to the INPUT connector on the spectrum analyzer. See Figure 2-9.
3. Use the 50  $\Omega$  SMA terminator to terminate the Channel 1 Analog connector on the AWG7000. See Figure 2-9.

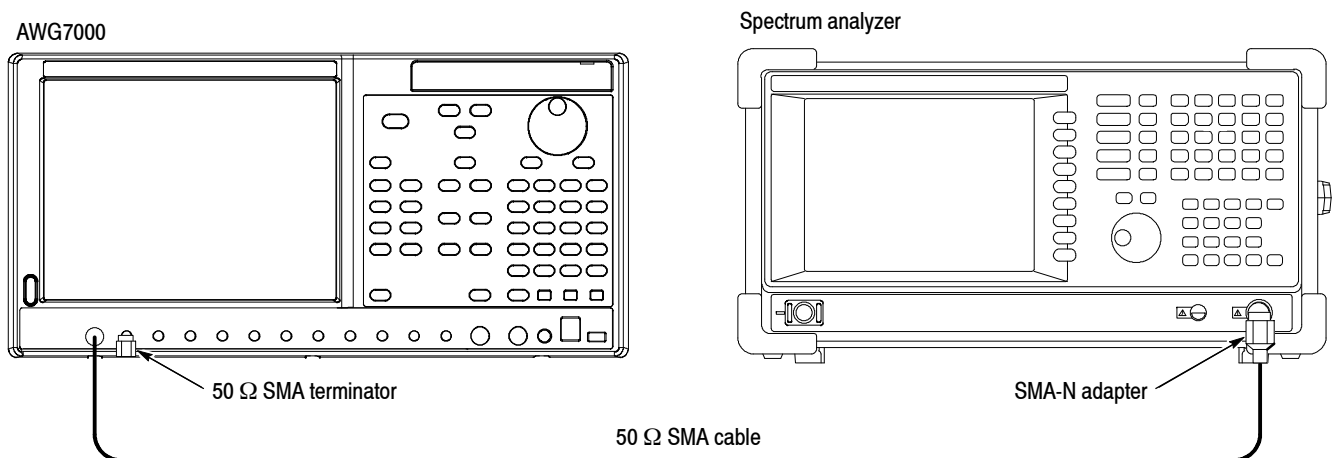

**Figure 2-9: Equipment connections for verifying the non-harmonic spurious signal**

4. Press the **Factory Default** button on the AWG7000.
5. Press the **Ch1 Select** button on the AWG7000.

6. On the AWG7000, load the **sine\_32** waveform as an output waveform.
  - a. Press the **File Open** button or select **File > Open File** to open the Open dialog box.
  - b. In the dialog box, navigate to the **C:\Program Files\Tektronix\AWG\System\PV** directory, and then select the **pv\_awg7000.awg** file. The **Waveform List** window appears.
  - c. In the window, select (drag and drop) the **sine\_32** waveform on the **User Defined** tab.
7. Press the **Ch 1 On** button on the AWG7000 to enable the channel 1 output.
8. Press the **Run** button on the AWG7000 to output the waveform.
9. Make the AWG7000 and spectrum analyzer settings shown in the first row (or the corresponding row for your instrument) of Table 2-6.

**Table 2-6: Analog non-harmonic spurious signal**

AWG7000 model and settings				Spectrum analyzer settings			Accuracy Limit
Model	Output mode	Amplitude	Sampling rate (output frequency)	Center frequency	Span	RBW	
AWG710x	Direct out: On/Off	1.0 Vp-p	10 GS/s (312.5 MHz)	1.5 GHz	3 GHz	1 MHz	< -50 dBc
				2 GHz	3 GHz	1 MHz	
				4 GHz	3 GHz	1 MHz	
AWG7101 Option 02	-----	1.0 Vp-p	10 GS/s (312.5 MHz)	1.5 GHz	3 GHz	1 MHz	< -50 dBc
				2 GHz	3 GHz	1 MHz	
				4 GHz	3 GHz	1 MHz	
AWG7102 Option 06	Interleave: Off	1.0 Vp-p	10 GS/s (312.5 MHz)	1.5 GHz	3 GHz	1 MHz	< -50 dBc
				2 GHz	3 GHz	1 MHz	
				4 GHz	3 GHz	1 MHz	
AWG705x	Direct out: On/Off	1.0 Vp-p	5 GS/s (156.25 MHz)	1.5 GHz	3 GHz	1 MHz	< -50 dBc
AWG705x Option 02	-----	1.0 Vp-p	5GS/s (156.25 MHz)	1.5 GHz	3 GHz	1 MHz	< -50 dBc



10. Use the spectrum analyzer to measure non-harmonic spurious signal of the Analog output over a frequency range of DC to 5 GHz (for the AWG705x, DC to 2.5 GHz). For example, note the reference level of the fundamental waveform, and then measure each spurious.
11. Verify that the non-harmonic spurious signal falls within the limits given in Table 2-6.
12. Repeat steps 9 through 12 for each setting in Table 2-6.
13. *For the AWG7102 or AWG7052:* Repeat the test for the Channel 2 output.
14. Press the **All Outputs On/Off** button on the AWG7000 to turn off all the outputs.
15. Disconnect the test setup.

## Analog Phase Noise

<b>Equipment required</b>	Spectrum analyzer 50 $\Omega$ SMA cable SMA-N adapter 50 $\Omega$ SMA terminator
<b>Prerequisites</b>	As listed under <i>Prerequisites</i> on page 2-9.

1. Press the **All Outputs On/Off** button on the AWG7000 to turn off all the outputs.
2. Use the 50  $\Omega$  SMA cable and SMA-N adapter to connect the Channel 1 Analog connector on the AWG7000 to the INPUT connector on the spectrum analyzer. See Figure 2-10 on page 2-32.
3. Use the 50  $\Omega$  SMA terminator to terminate the Channel 1 Analog connector on the AWG7000. See Figure 2-10 on page 2-32.

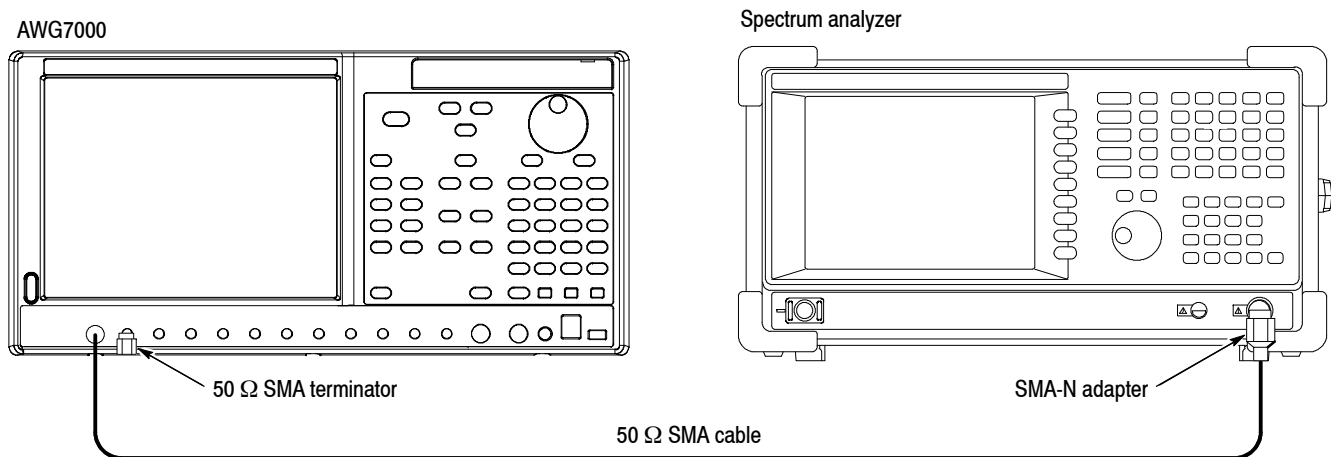

**Figure 2-10: Equipment connections for verifying the analog phase noise**

4. Press the **Factory Default** button on the AWG7000.
5. On the AWG7000, load the **sine\_32** waveform as an output waveform.
  - a. Press the **File Open** button or select **File > Open File** to open the Open dialog box.
  - b. In the dialog box, navigate to the **C:\Program Files\Tektronix\AWG\System\PV** directory, and then select the **pv\_awg7000.awg** file. The **Waveform List** window appears.
  - c. In the window, select (drag and drop) the **sine\_32** waveform on the **User Defined** tab.
6. Press the **Ch 1 On** button on the AWG7000 to enable the channel 1 output.
7. Press the **Run** button on the AWG7000 to output the waveform.
8. Make the AWG7000 and spectrum analyzer settings shown in the first row (or the corresponding row for your instrument) of Table 2-7.
9. Use the spectrum analyzer to measure phase noise of the Analog output.
10. Verify that the analog phase noise at 10 kHz offset falls within the limits given in Table 2-7.
11. Repeat steps 8 through 12 for each row in Table 2-7.
12. *For the AWG7102 or AWG7052:* Repeat the test for the Channel 2 output.
13. *For the AWG7102 Option 06:* Repeat the test for Interleave output.

Table 2-7: Analog phase noise

AWG7000 model and settings				Spectrum analyzer settings			Accuracy Limit at 10 kHz offset
Model	Output mode	Amplitude	Sampling rate	Center frequency	Span	RBW	
AWG710x	Direct out: On/Off	1.0 Vp-p	10 GS/s	312.5 MHz	50 kHz	100 Hz	< -90 dBc/Hz
AWG7101 Option 02	-----	1.0 Vp-p	10 GS/s	312.5 MHz	50 kHz	100 Hz	< -90 dBc/Hz
AWG7102 Option 06	Interleave: Off	1.0 Vp-p	10 GS/s	312.5MHz	50 kHz	100 Hz	< -90 dBc/Hz
	Interleave: On Zeroing: Off	1.0 Vp-p	20 GS/s	625 MHz	50 kHz	100 Hz	< -85 dBc/Hz
	Interleave: On Zeroing: On	0.5 Vp-p	20 GS/s	625 MHz	50 kHz	100 Hz	< -85 dBc/Hz
AWG705x	Direct out: On/Off	1.0 Vp-p	5 GS/s	156.25 MHz	50 kHz	100 Hz	< -90 dBc/Hz
AWG705x Option 02	-----	1.0 Vp-p	5GS/s	156.25 MHz	50 kHz	100 Hz	< -90 dBc/Hz

14. Press the **All Outputs On/Off** button on the AWG7000 to turn off all the outputs.
15. Disconnect the test setup.

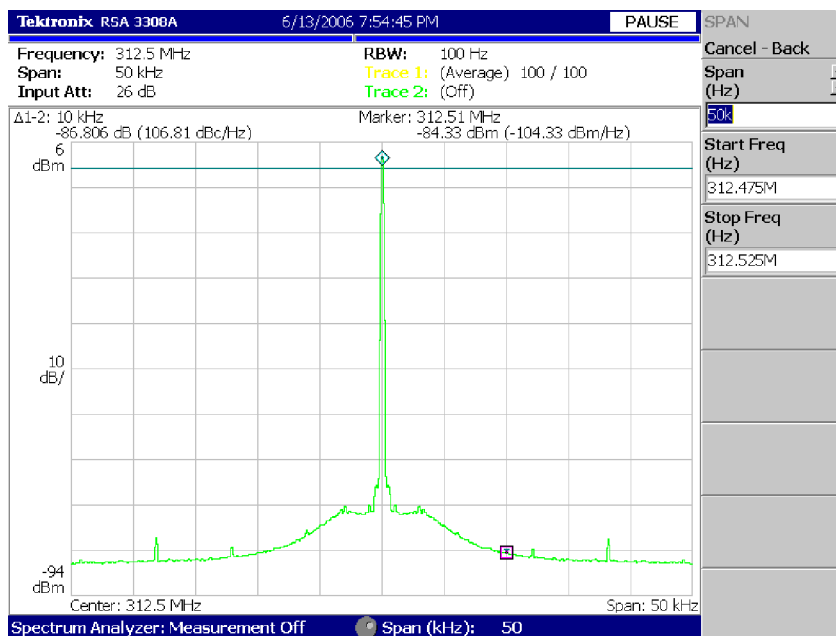
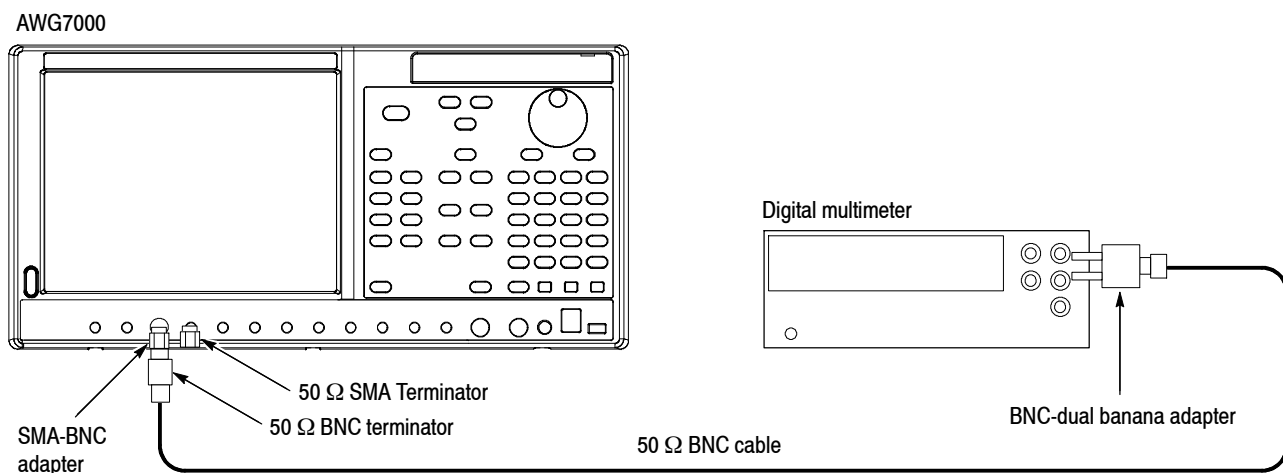

Figure 2-11: Example of the analog phase noise measurement

## Marker High and Low Level Accuracy

<b>Equipment required</b>	Digital multimeter 50 $\Omega$ BNC cable SMA-BNC adapter 50 $\Omega$ BNC terminator BNC-dual banana adapter 50 $\Omega$ SMA terminator
<b>Prerequisites</b>	As listed under <i>Prerequisites</i> on page 2-9.

1. Perform *Measuring Terminator Resistance* on page 2-21.
2. Press the **All Outputs On/Off** button on the AWG7000 to turn off all the outputs.
3. Use the 50  $\Omega$  BNC cable, SMA-BNC adapter, 50  $\Omega$  BNC terminator, and BNC-Banana adapter to connect the Channel 1 Mkr 1 connector on the AWG7000 to the HI and LO inputs on the digital multimeter. See Figure 2-12.
4. Use the 50  $\Omega$  SMA terminator to terminate the Channel 1  $\overline{\text{Mkr 1}}$  connector on the AWG7000. See Figure 2-12.



**Figure 2-12: Equipment connection for verifying the marker high and low level accuracy**

5. Press the **Factory Default** button on the AWG7000.
6. Press the **Ch1 Select** button on the AWG7000.
7. On the AWG7000, load the **marker\_hi** waveform as an output waveform.
  - a. Press the **File Open** button or select **File > Open File** to open the Open dialog box.
  - b. In the dialog box, navigate to the **C:\Program Files\Tektronix\AWG\System\PV** directory, and then select the **pv\_awg7000.awg** file. The **Waveform List** window appears.
  - c. In the window, select the **marker\_hi** waveform on the **User Defined** tab.
8. Press the **Ch 1 On** button on the AWG7000 to enable the channel 1 output.
9. Press the **Run** button on the AWG7000 to output the waveform.
10. Make the AWG7000 High Level setting shown in the first row of Table 2-8.

**Table 2-8: Marker High and Low level accuracy**

High level settings	Accuracy limits
+ 1.4 V	1.21 V to 1.59 V
0.0 V	-50 mV to +50 mV
-0.9 V	-1.04 V to -0.76 V
Low level settings	Accuracy limits
+ 0.9 V	0.76 V to 1.04 V
0.0 V	-50 mV to +50 mV
-1.4 V	-1.59 V to -1.21 V

11. Measure the output voltage on the digital multimeter and note the value as **Measured\_voltage\_1**.
12. Use the following formula to compensate the voltage for the 50  $\Omega$  BNC terminator:
 
$$\text{Marker\_High} = (\text{Term\_R} + 50) / (2 \times \text{Term\_R}) \times \text{Measured\_voltage\_1}$$
13. Verify that the marker High level falls within the limits given in Table 2-8.
14. Repeat steps 10 through 13 for each row in Table 2-8.
15. In the **Waveform List** window, select the **marker\_low** waveform on the **User Defined** tab.

16. Press the **Ch 1 On** button on the AWG7000 to enable the channel 1 output.
17. Press the **Run** button on the AWG7000 to output the waveform.
18. Make the AWG7000 Low Level setting shown in the first row of Table 2-8 on page 2-35.
19. Measure the output voltage on the digital multimeter and note the value as **Measured\_voltage\_2**.
20. Use the following formula to compensate the voltage for the 50  $\Omega$  BNC terminator:  
$$\text{Marker\_Low} = (\text{Term\_R} + 50) / (2 \times \text{Term\_R}) \times \text{Measured\_voltage\_2}$$
21. Verify that the marker Low level falls within the limits given in Table 2-8 on page 2-35.
22. Repeat steps 18 through 21 for each row in Table 2-8 on page 2-35.
23. Press the **Ch 1 On** button to disable the channel 1 output.
24. Move the SMA-BNC adapter from the Channel 1 Mkr 1 connector to the Channel 1 Mkr 1 connector and move the 50  $\Omega$  SMA terminator from the Channel 1 Mkr 1 connector to the Channel 1 Mkr 1 connector.

---

*NOTE. For the Mkr 1 output, read marker\_low and marker\_hi as marker\_low and marker\_hi respectively.*

---

25. Repeat steps 8 through 22.
26. Repeat steps 8 through 25 for Channel 1 Mkr 2 and Mkr 2.
27. For the AWG7102 or AWG7052: Repeat the test for the Channel 2 marker outputs.
28. Press the **All Outputs On/Off** button on the AWG7000 to turn off all the outputs.
29. Disconnect the test setup.

## Marker Output Delay Accuracy

<b>Equipment required</b>	Sampling oscilloscope Two 50 $\Omega$ SMA cables Two 50 $\Omega$ SMA terminators Two 50 $\Omega$ SMA attenuators
<b>Prerequisites</b>	As listed under Prerequisites on page 2-9.

1. Press the **All Outputs On/Off** button on the AWG7000 to turn off all the outputs.
2. Use a 50  $\Omega$  SMA cable and 50  $\Omega$  SMA attenuator to connect the Channel 1 Mkr 1 connector on the AWG7000 to the CH1 connector on the sampling oscilloscope. See Figure 2-13.
3. Use the 50  $\Omega$  SMA cable and 50  $\Omega$  SMA attenuator to connect the Channel 1 Analog connector on the AWG7000 to the TRIGGER DIRECT connector on the sampling oscilloscope. See Figure 2-13.
4. Use a 50  $\Omega$  SMA terminator to terminate the Channel 1 Analog connector on the AWG7000. See Figure 2-13.
5. Use the 50  $\Omega$  SMA terminator to terminate the Channel 1 Mkr 1 connector on the AWG7000. See Figure 2-13.

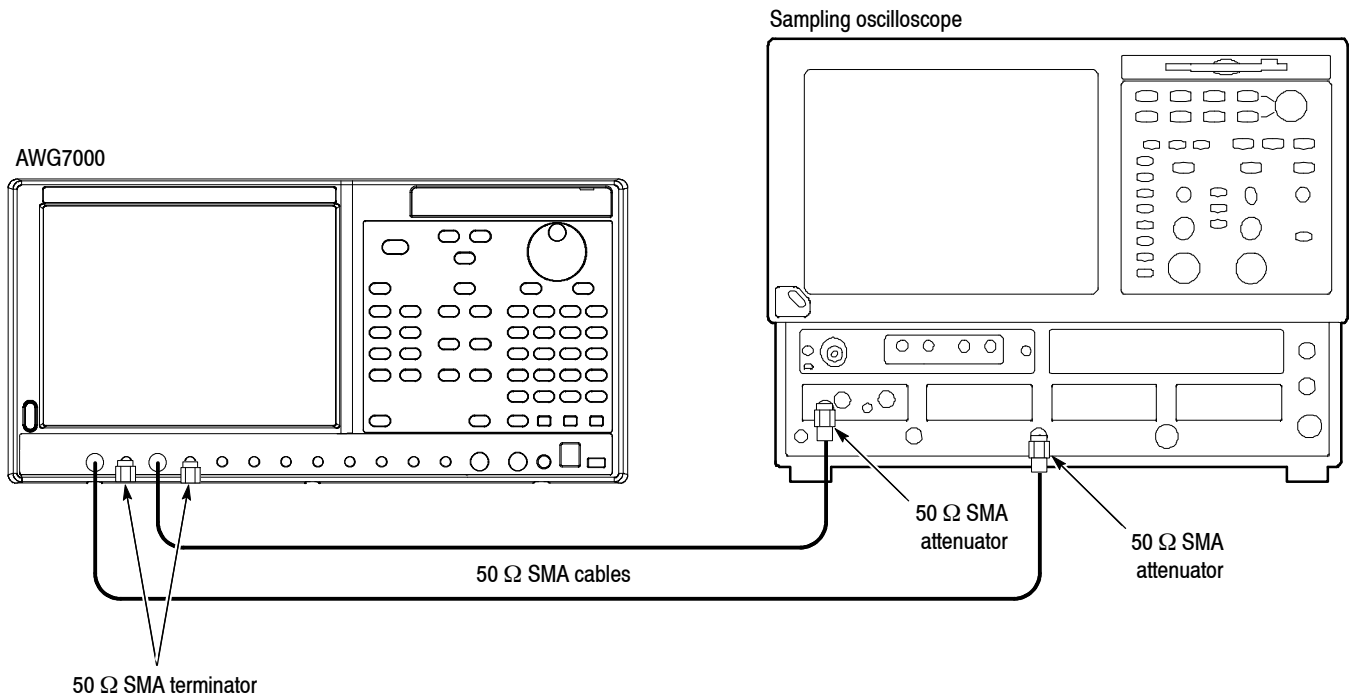

**Figure 2-13: Equipment connections for verifying the marker output delay accuracy**

6. Set the sampling oscilloscope settings as indicated below:
  - Vertical scale . . . . . 250 mV/div
  - Horizontal scale . . . . . 100 ps/div
  - Trigger source . . . . . External Direct
  - Trigger level . . . . . 0 V
  - Trigger slope . . . . . positive
  - Measure . . . . . Pulse measurement > Pulse Time > Delay
7. Press the **Factory Default** button on the AWG7000.
8. On the AWG7000, load the **square1** waveform as an output waveform.
  - a. Press the **File Open** button or select **File > Open File** to open the Open dialog box.
  - b. In the dialog box, navigate to the **C:\Program Files\Tektronix\AWG\System\PV** directory, and then select the **pv\_awg7000.awg** file. The **Waveform List** window appears.
  - c. In the window, select the **square1** waveform on the **User Defined** tab.
9. Press the **Ch 1 On** button on the AWG7000 to enable the channel 1 output.
10. Press the **Run** button on the AWG7000 to output the waveform.



11. On the oscilloscope, store the channel 1 waveform to **Ref 1** as a reference waveform.
12. On the AWG7000, set the **Marker 1** delay value to **150 ps**.
13. Use the oscilloscope to measure the delay time between the Ref 1 waveform and channel 1 waveform at the 50% level.
14. Verify that the delay time is within the range of 92.5 ps to 207.5 ps.
15. Press the **Ch 1 On** button on the AWG7000 to disable the channel 1 output.
16. Move the SMA cable from the Channel 1 Mkr 1 connector to the Channel 1 Mkr 2 connector.
17. Move the SMA terminator from the Channel 1 Mkr 1 connector to the Channel 1 Mkr 2 connector.
18. Press the **Ch 1 On** button on the AWG7000 to enable the channel 1 output.
19. On the oscilloscope, store the channel 1 waveform to **Ref 1** as a reference waveform.
20. On the AWG7000, set the **Marker 2** delay value to **150 ps**.
21. Repeat steps 13 and 14.
22. *For the AWG7102 and AWG7052:* Repeat the test for the Marker 1 and Marker 2 of the Channel 2.
23. Press the **All Outputs On/Off** button on the AWG7000 to turn off all the outputs.
24. Disconnect the test setup.

## DC Output Voltage Accuracy

<b>Equipment required</b>	Digital multimeter
	DC output lead set
	Test leads (provided with the digital multimeter)
<b>Prerequisites</b>	As listed under <i>Prerequisites</i> on page 2-9.

1. Use the test leads to connect the HI and LO inputs on the digital multimeter. See Figure 2-14.
2. Use the DC output lead set to connect the DC Output connector on the AWG7000. See Figure 2-14.

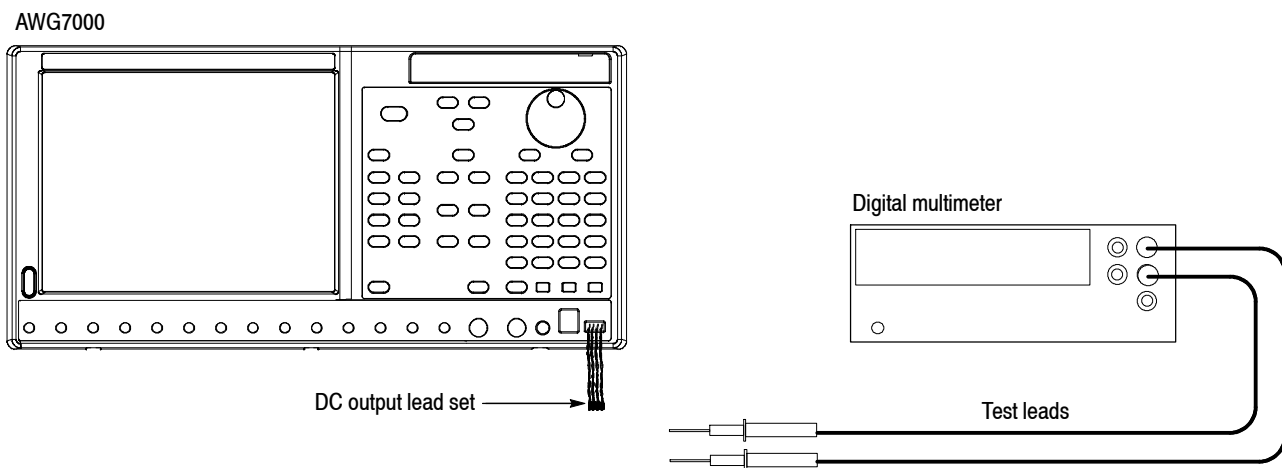

**Figure 2-14: Equipment connection for verifying the DC output voltage accuracy**

3. Set the digital multimeter to the **VDC** mode.
4. On the AWG7000, select the **DC Outputs** tab in the **Settings** window.
5. On the DC Output tab, set the DC 1, DC 2, DC 3, and DC 4 levels to the setting shown in the first row of Table 2-9 on page 2-41.

**Table 2-9: DC output voltage accuracy**

<b>Model</b>	<b>DC output settings</b>	<b>Accuracy limits</b>
AWG7000	+5 V	4.77 V to 5.23 V
	+3 V	2.83 V to 3.17 V
	0.0 V	-80 mV to +80 mV
	-3 V	-3.17 V to -2.83 V

6. On the DC Outputs tab, select the **DC Output** check box to enable the DC output. The DC Output LED on the front panel lights.
7. Attach the black test lead to the connector lead from DC1 GND.
8. Attach the red test lead to the connector lead from DC1.
9. Verify that the DC output level falls within the limits given in Table 2-9.
10. Repeat steps 8 through 9 for DC 2, DC 3, and DC 4.
11. Repeat steps 5 through 10 for each row in Table 2-9.

This completes the AWG7000 performance verification.

